

66506 Table Dance Bar „Eden“ H0 · Table Dancing Bar „Eden“ H0 · Club Nocturno Table Dance H0 · Club de nuit „Eden“ H0



Deutsch:

Vor Gebrauch die Sicherheitshinweise und Anleitung genau lesen und beachten.

Dieser Artikel ist ein Modellbauartikel für anspruchsvolle Modellbauer und Sammler. Aufgrund maßstabs- und vorbildgetreuer bzw. funktionsbedingter Gestaltung sind Spitzen, Kanten und filigrane Kleinteile enthalten. Für den Zusammenbau sind Werkzeuge wie ein scharfes Bastelmesser, eine scharfe Schere und spezieller Kleber nötig. **Die fachgerechte**

Weiterverarbeitung dieses Modellbauproduktes birgt daher ein Verletzungsrisiko! Das Produkt gehört aus diesem Grund nicht in die Hände von Kindern! Nach Fertigstellung ist dieser Artikel zum Einbau (Fixierung z.B. durch Klebstoff) in eine Modellbahnanlage, Schaustück usw. und als hochwertiger Dekorationsartikel vorgesehen. Kein Spielzeug.

Diesen Bausatz sowie Zubehör (Klebstoffe, Farben, Messer usw.) unbedingt außer Reichweite von Kindern unter 3 Jahren halten. Lassen Sie Kinder nur unter fachkundiger Aufsicht von erwachsenen Modellbauern diese Bausätze bearbeiten.

Nur die diesem Bausatz beiliegenden Teile und empfohlenes Zubehör verwenden. Hände und Werkzeug nach dem Basteln säubern.

Bei der Verwendung von Farben und Klebstoffen unbedingt beachten: Nicht essen, trinken oder rauchen. Farben und Klebstoffe nicht mit Augen, Haut oder Mund in Berührung bringen. Dämpfe nicht einatmen. Von Zündquellen fernhalten. Die Anleitung und Hinweise des Herstellers genau beachten. **Erste Hilfe bei Augenkontakt:** Auge unter fließendem Wasser ausspülen und dabei offen halten. Umgehend ärztliche Hilfe konsultieren.

Diese Information gut aufbewahren.

Herzlichen Dank, dass Sie sich für einen Laser-Cut Bausatz von NOCH entschieden haben. Wenn Sie einige Hinweise beachten, ist ein perfektes Ergebnis sehr leicht zu erzielen.

Säubern der Teile: Beim Lasergravieren der Teile entsteht durch das Verbrennen des Materials sogenannter Schmutz, der sich auf den Teilen absetzt. Dies betrifft vor allem Fensterläden, Fensterleibungen, Dachunterkonstruktion und Holzverkleidungen. Sie sollten diese Teile daher vor dem Zusammenbau reinigen. Hierzu eignet sich eine alte Zahnbürste. Außerdem könne Sie die Teile mit dem NOCH Haft- und Fixierspray (Art. Nr. 61152) versiegeln. Waschen Sie sich nach dem Säubern der Teile die Hände.

ACHTUNG: Die Reihenfolge ist strikt einzuhalten. Bitte orientieren Sie sich an den Abbildungen um die Position der Teile zu ermitteln. Prüfen Sie vor dem Verkleben der Teile immer den korrekten Sitz und die Passgenauigkeit.



... wie im Original

English:

Read and follow these safety precautions and instructions carefully before use.

This product is a model building item for the experienced modeller and collector. Due to its life-like and true to scale reproduction and functional form, this product contains peaks, edges and delicate small parts. For assembly, tools like a sharp cutter, a sharp pair of scissors and special glue are necessary. **Therefore, appropriate working with this model building kit does present a risk of injury!** For that reason this product is not for children! Upon completion, this product is designed to be installed (e.g. fixed with glue) on to a model railway layout, diorama etc. and as a high-quality decorative item and not a toy.

Keep this kit as well as all accessories (glue, paints, cutter etc.) out of reach of children under 3 years of age! Let children build this kit only if supervised by a competent adult modeller.

Only use the parts of this kit included and recommended accessories. Please wash your hands and tools after modelling.

For use of paints and glues please follow these safety precautions: Do not eat, drink or smoke. Avoid any contact with eyes, skin or mouth. Do not breathe any vapours. Keep away from ignition sources. Follow the instructions and safety precautions of the manufacturer carefully. **First aid for contact with eyes:** Flush the eye with clean water holding the eyelid open. Immediately consult medical advice.

Keep these instructions safe.

Thank you very much for purchasing a NOCH Laser-Cut+ kit. You will very easily obtain a perfect result if you carefully read the following instructions:

Cleaning of the parts: Some parts such as shutters, bracing, roof structures and timbers may show some burn traces on the edges caused by the laser cutting process. Please clean these parts before you start to assemble. An old toothbrush will be very helpful for such cleaning. Additionally you may also seal them with NOCH spray glue (ref. 61152). After you have cleaned the parts please wash your hands.

ATTENTION: Please strictly adhere to these assembly steps and always refer to the pictures to find the position of the parts. Before glueing please verify that all parts fit accurately.

Français:

Avant d'utiliser ce produit, veuillez lire et suivre attentivement les consignes de sécurité et le mode d'emploi.

Ce produit est un modèle réduit pour modélistes et collectionneurs exigeants. En raison d'une reproduction fidèle à l'échelle de l'original ainsi qu'un respect de la fonctionnalité, les kits contiennent objets pointus, des arêtes et des petites pièces filigranes.

Pour le montage, des outils tels une lame aiguisée, des ciseaux aiguisés ainsi qu'une colle spéciale sont nécessaires. **De ce fait, un risque de blessure est possible!** Pour cette raison, tenir ce produit hors de portée des enfants! Après finition, ce produit est destiné à être intégré (p. ex. fixation avec de la colle) dans un réseau, un diorama etc. et peut être utilisé comme un produit décor de haute qualité. Ce n'est pas un jouet.

Tenir absolument ce kit et les accessoires (colle, peintures, lames etc.) hors de portée des enfants de moins de 3 ans!

N'utiliser que les pièces jointes et les accessoires recommandés. Nettoyer les mains et les outils après l'usage.

Pour l'utilisation des colles et des peintures, veuillez suivre les précautions suivantes: Ne pas manger, boire ou fumer lors de la manipulation. Éviter tout contact avec les yeux, la peau et la bouche. Ne pas inhaler les vapeurs. Tenir à l'écart des sources inflammables. Veuillez suivre attentivement le mode d'emploi et les indications du fabricant. **Premiers secours en cas de contact avec les yeux:** Rincer immédiatement et abondamment à l'eau en les maintenant ouverts et consulter un ophtalmologiste.

Veuillez bien conserver ces instructions.

Merci beaucoup d'avoir acheté un kit Laser-Cut+ NOCH. Vous obtiendrez très facilement un résultat parfait, grâce aux instructions suivantes :

Nettoyage des pièces: Certaines pièces, telles que les volets, les embrasures, la charpente et le lambrissage peuvent présenter sur leurs bords certaines traces de brûlure causées par la coupe au laser. Veuillez nettoyer ces pièces avant de commencer l'assemblage. Une vieille brosse à dents peut se montrer utile pour le nettoyage. De plus, vous pouvez également les sceller avec notre colle en spray NOCH (réf. 61152). Veuillez vous laver les mains après le nettoyage des pièces.

Attention : Veuillez strictement respecter ces étapes et vous référer aux images pour trouver la position des pièces. Avant de coller, vérifiez que toutes les pièces soient à la bonne taille.



... wie im Original

Español

Antes de montar leer las instrucciones de seguridad e indicaciones de montaje.

Este artículo es para modelistas y coleccionistas exigentes. Dado que las piezas son réplicas a medida y en algunos casos con funcionamiento, los modelos pueden tener partes puntiagudas, cantos y piezas filigranas. Para su montaje se necesitan un cuchillo afilado, una tijera que corte y un pegamento especial. **El manipulado posterior de este producto puede llevar consigo un riesgo a lesionarse.** ¡Debido a ello este artículo no puede estar al alcance de los niños! Una vez acabado este artículo se puede montar en una maqueta (p.e. con pegamento), en el escaparate o como decoración. No es un juguete.

¡En ningún momento dejar el kit de montaje así como los accesorios (pegamento, colores, cuchillos, etc.) al alcance de niños menores de 3 años! La utilización de este producto por niños deberá realizarse solo bajo vigilancia de un adulto modelista.

Solamente utilizar las piezas adjuntas y los accesorios indicados. Después del trabajo de bricolaje limpiar las herramientas y las manos.

Al utilizar los colores y pegamentos es indispensable: no comer, beber ni fumar. Los ojos, la piel y la boca no deben entrar en contacto con los colores y pegamentos. No inhalar los vapores. No dejar cerca de fuentes de calor. Seguir exactamente las Instrucciones e indicaciones del fabricante. **Primer auxilio cuando hubo contacto con el ojo:** lavar el ojo con agua corriente y mantenerlo abierto. Buscar inmediatamente ayuda médica.

Guardar bien esta información.

Muchas gracias por haber elegido este kit cortado a láser de NOCH. Teniendo en cuenta las indicaciones siguientes, se conseguirá fácilmente un resultado de montaje perfecto.

Limpiar las piezas: Durante el proceso de cortar las piezas por láser se pueden producir huellas de quemadura. Esto afecta sobre todo las contraventanas, marcos de ventana, partes inferiores de tejado y revestimientos de madera. A causa de esto se debe limpiar las piezas antes del montaje p.e. con un cepillo de dientes. Adicionalmente se puede lacrar las piezas con espray adhesivo y fijativo (ref. 61152). Lave sus manos después de haber limpiado las piezas.

ATENCIÓN: Es imprescindible de seguir el orden numérico. Para saber la posición de las piezas utilice por favor las imágenes. Compruebe antes de pegar las piezas si están en la posición correcta y si encajan.

Nederlands

Voor gebruik de veiligheidswaarschuwingen en instructies goed lezen en opvolgen.

Dit product is een modelbouwartikel voor veeleisende modelbouwers en verzamelaars. Op basis van schaalverhoudingen, natuurgetrouwe- en functionele nabootsing zijn er scherpe punten en andere kleine, zeer fijne onderdelen aanwezig. Voor het in elkaar zetten is gereedschap zoals een scherp knutselmes, een scherpe schaar en speciale lijm nodig. **Hierdoor vormt ook vakkundige verwerking van dit modelbouwproduct kans op letsel!** Daarom buiten bereik van kinderen houden! Na voltooiing is dit artikel bedoeld voor plaatsing (vastzetten met bijvoorbeeld lijm) op een modelspoorweg, diorama etc. en als hoogwaardig decoratieartikel bedoeld. Geen speelgoed.

Deze bouwdoos en toebehoren (lijm, verf, messen enz.) absoluut buiten bereik van kinderen onder de 3 jaar houden! Laat kinderen alleen onder vakkundige begeleiding van een volwassen modelbouwer deze bouwset bewerken.

Alleen de in deze bouwdoos ingesloten onderdelen en aanbevolen accessoires gebruiken. Handen en gereedschap na gebruik goed reinigen.

Let op bij het gebruik van verf en lijm: niet eten, drinken of roken. Verf en lijm niet in aanraking brengen met ogen, huid of mond. Niet inademen. Verwijderd houden van ontstekingsbronnen. De handleiding en instructies van de fabrikant nauwkeurig opvolgen. **Eerste hulp bij oogcontact:** ogen open houden en met stromend water uitspoelen. Direct een arts raadplegen.

Deze informatie goed bewaren.

Hartelijk dank, dat u besloten heeft een Laser-Cut+ bouwset van NOCH te kopen. Wanneer u een paar aanwijzingen in acht neemt, is een perfect resultaat zeer gemakkelijk te behalen.

Schoonmaken van de onderdelen: Bij lasergraveren van onderdelen ontstaat door het verbranden van het materiaal zogenaamde smook, die zich op de onderdelen afzet. Het gaat dan vooral om raamluiken, kozijnstijlen, dakconstructies en houten oplegplaten. Deze onderdelen moet u voor het samenbouwen eerst schoonmaken. Hiervoor is een oude tandenborstel zeer geschikt. Bovendien kunt u de onderdelen met NOCH Haft- en fixeerspray (art. nr. 61152) fixeren. Was na het schoonmaken van de onderdelen uw handen.

LET OP: De bouwvolgorde moet strikt worden opgevolgd. Kijk naar de foto's om de posities van de onderdelen te bepalen. Controleer voor het lijmen altijd de goede plaats en kijk of het past.

Prima dell'uso leggere attentamente le istruzioni per l'uso e le avvertenze di sicurezza.

Questo prodotto è un articolo di modellismo per i modellisti e i collezionisti più esigenti. A causa della struttura in scala e fedele all'originale e della forma funzionale sono presenti unte, spigoli e piccole parti in filigrana. Per il montaggio sono necessari strumenti come un coltello affilato per modellismo, forbici taglienti e colla special. **Per questo la corretta lavorazione di questo prodotto di modellismo nasconde il rischio di ferirsi!** Per questo motivo occorre tenere il prodotto lontano dalla portata dei bambini! Una volta terminato, questo articolo è adatto per l'installazione (fissaggio ad es. con colla) in un plastic ferroviario, come pezzo da collezione o come pregiato articolo decorativo. Non è un giocattolo.

Tenere il kit di costruzione e gli accessori (colla, colori, coltello, ecc.) fuori dalla portata di bambini di età inferiore ai 3 anni!

Utilizzare esclusivamente i componenti forniti con il kit e gli accessori consigliati. Dopo il bricolage pulire mani e strumenti di lavoro.

Durante l'utilizzo di colori e colle attenersi alle seguenti indicazioni: Non mangiare, bere o fumare. Non portare i colori e la colla a contatto con occhi, pelle o bocca. Non respirare le esalazioni. Tenere lontano da fonti di ignizione. Osservare attentamente le istruzioni e le indicazioni del produttore. **Primo soccorso in caso di contatto con gli occhi:** Sciacquare gli occhi sotto l'acqua corrente tenendoli aperti. Consultare immediatamente un medico.

Conservare con cura queste informazioni.

Grazie per aver acquistato il kit Laser-Cut della NOCH. Otterrete facilmente un risultato perfetto grazie alle seguenti istruzioni:

Pulizia dei pezzi: Alcuni pezzi come imposte, stipiti, strutture del tetto e travi possono presentare sugli angoli tracce di bruciatura dovute al taglio laser. Prima di iniziare l'assemblaggio pulire questi particolari utilizzando anche un vecchio spazzolino da denti. Inoltre li potete anche sigillare usando la colla spray della NOCH (art. 61152). Dopo aver pulito i pezzi, lavare con cura le mani.

ATTENZIONE : Seguire attentamente passo per passo le istruzioni e fare sempre riferimento alle illustrazioni per trovare la posizione dei particolari. Prima di incollare verificare che tutti i particolari si incastrino accuratamente.

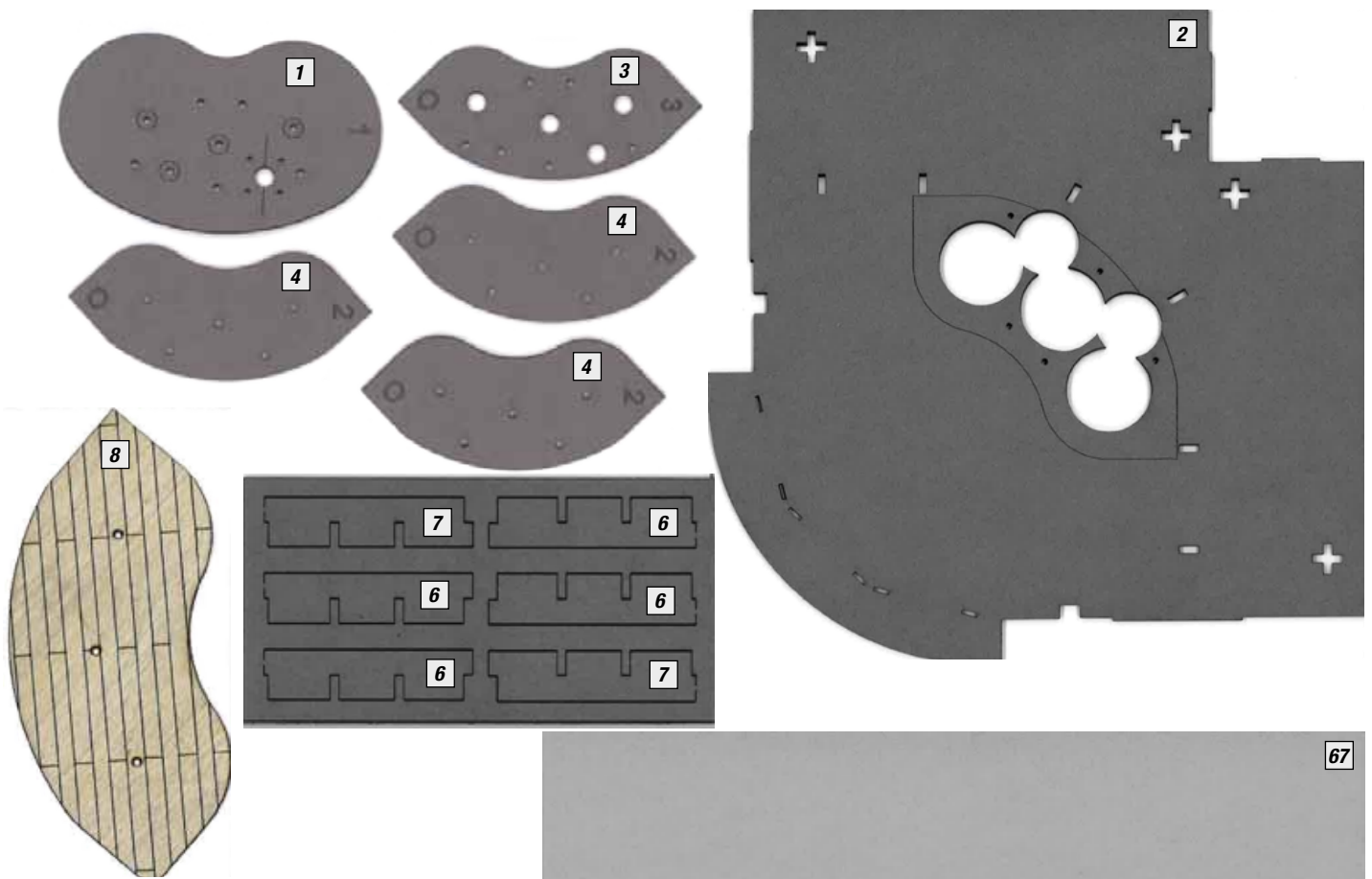

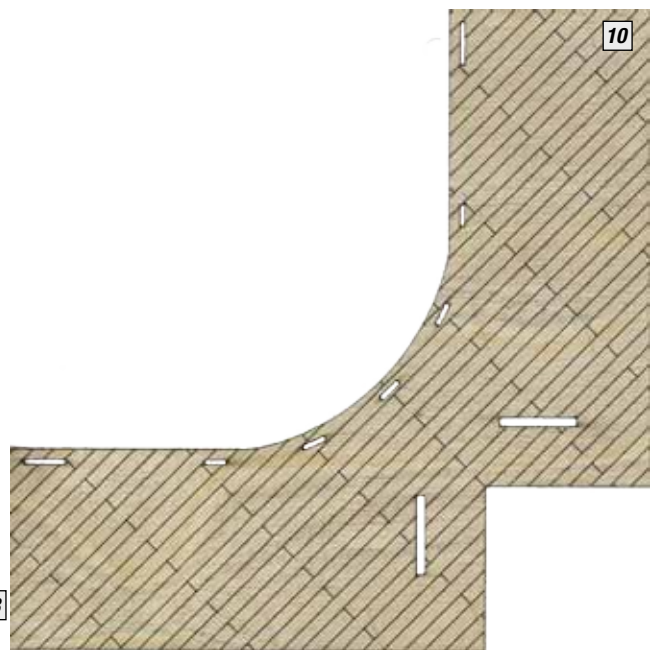
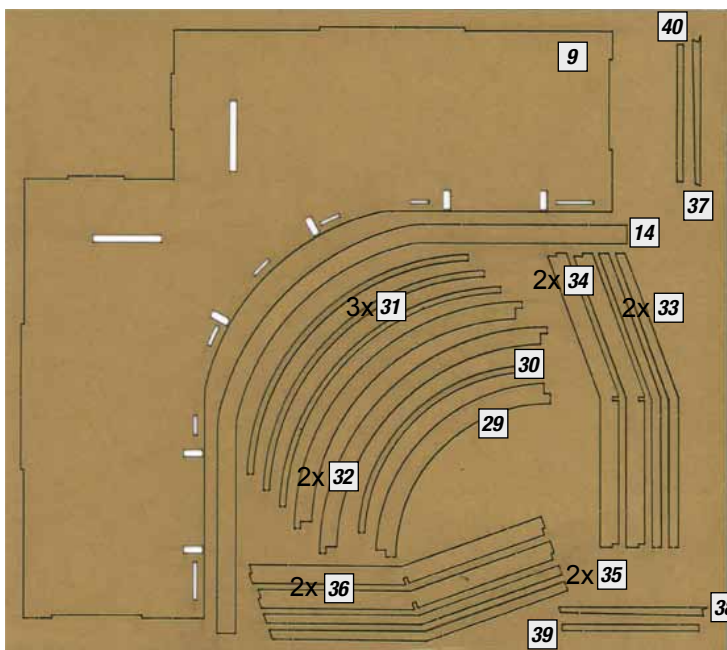
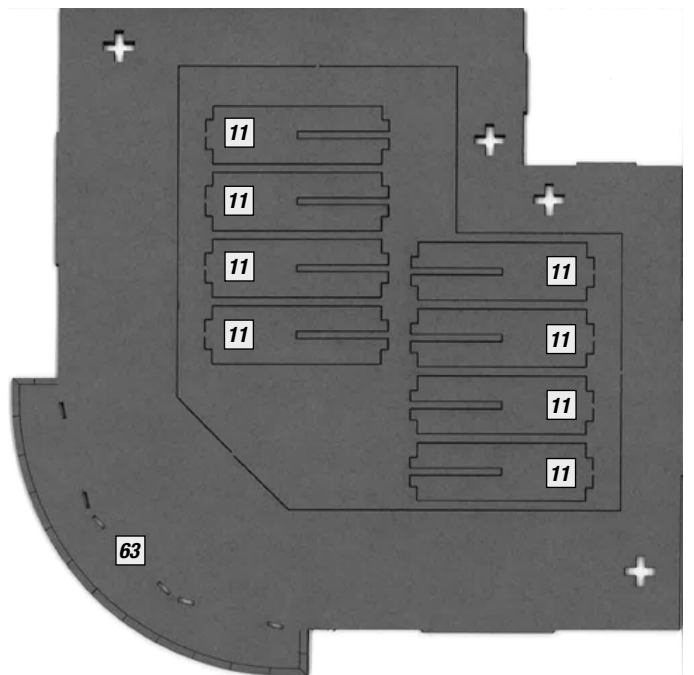
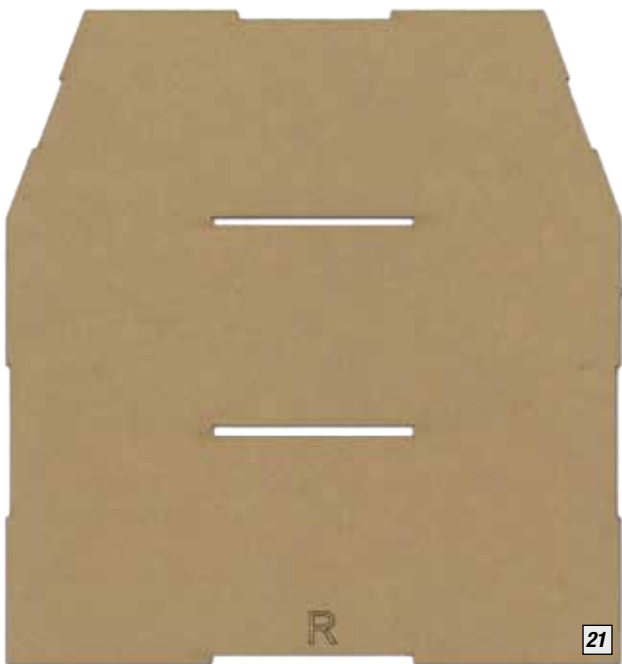
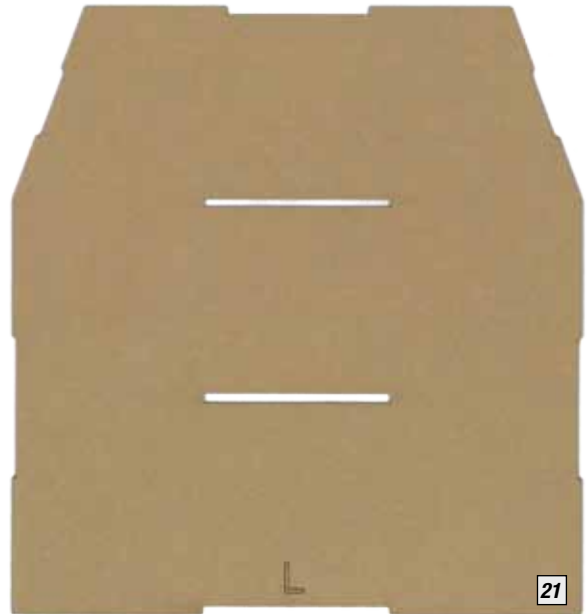

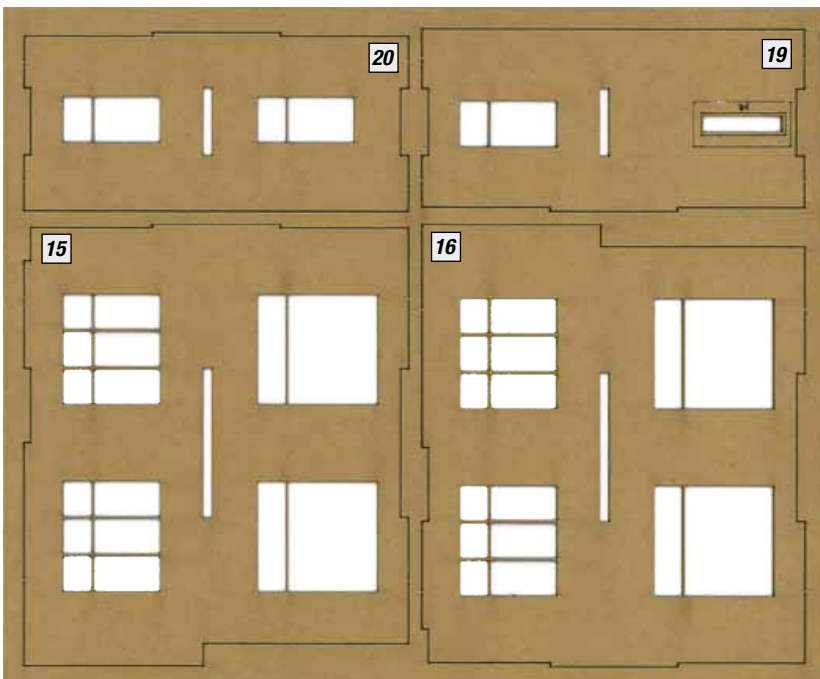
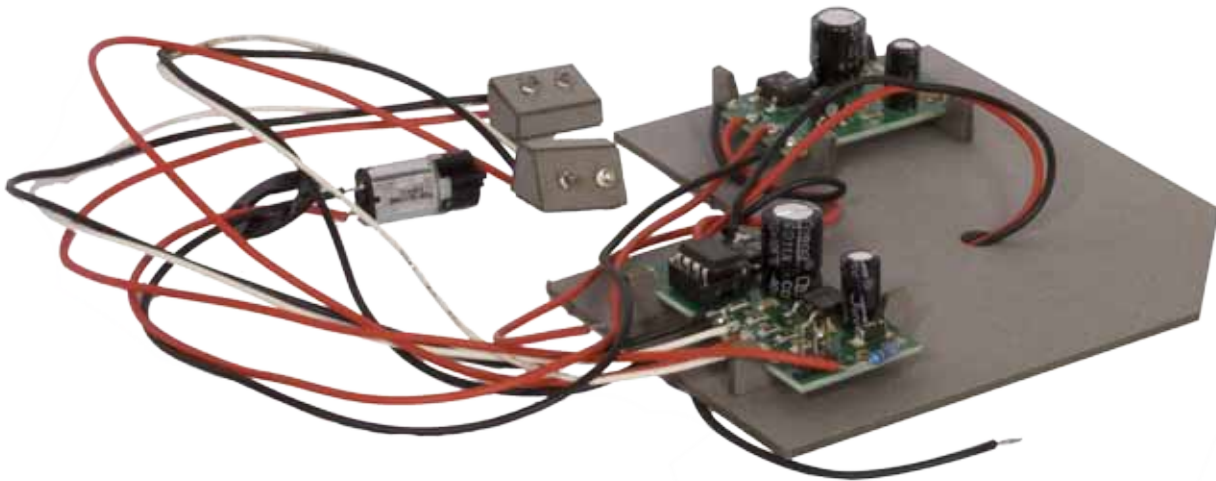
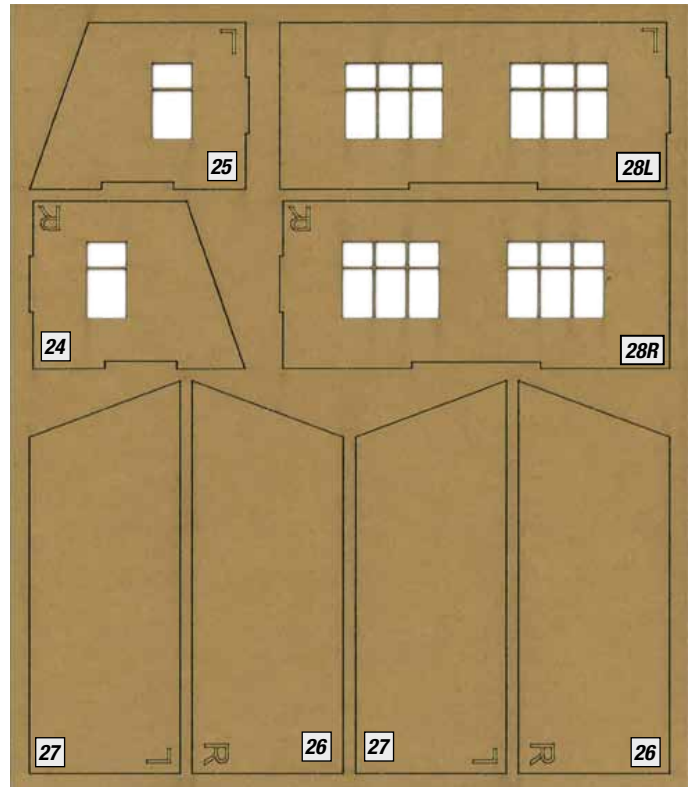
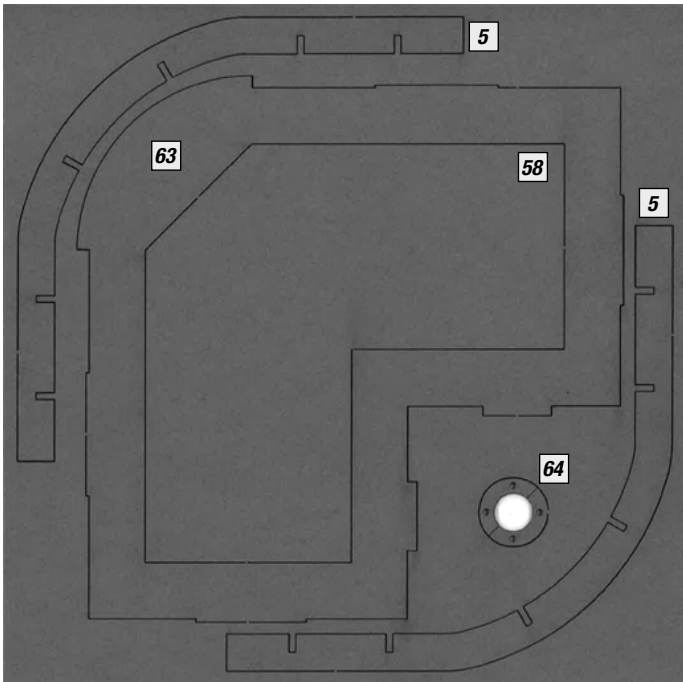

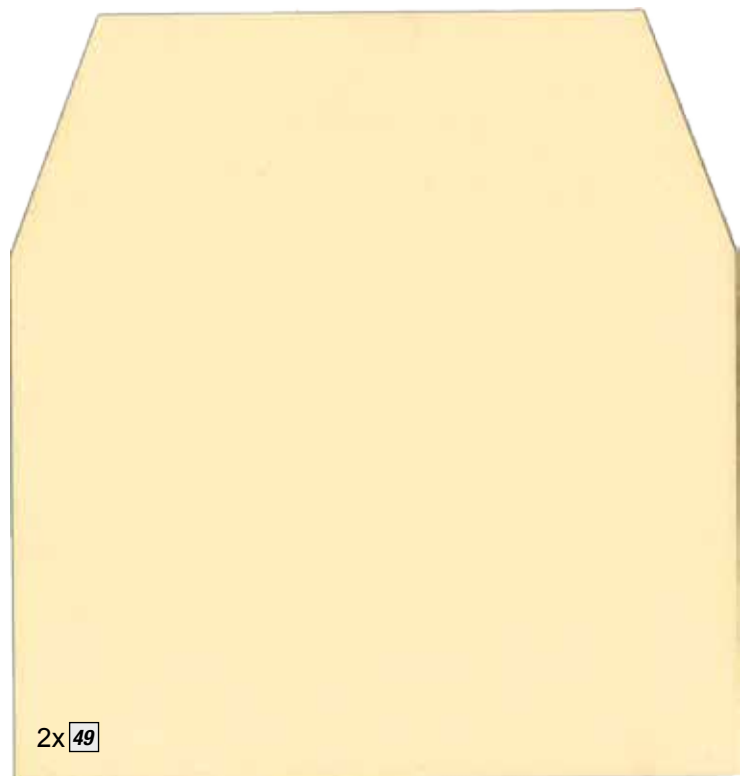
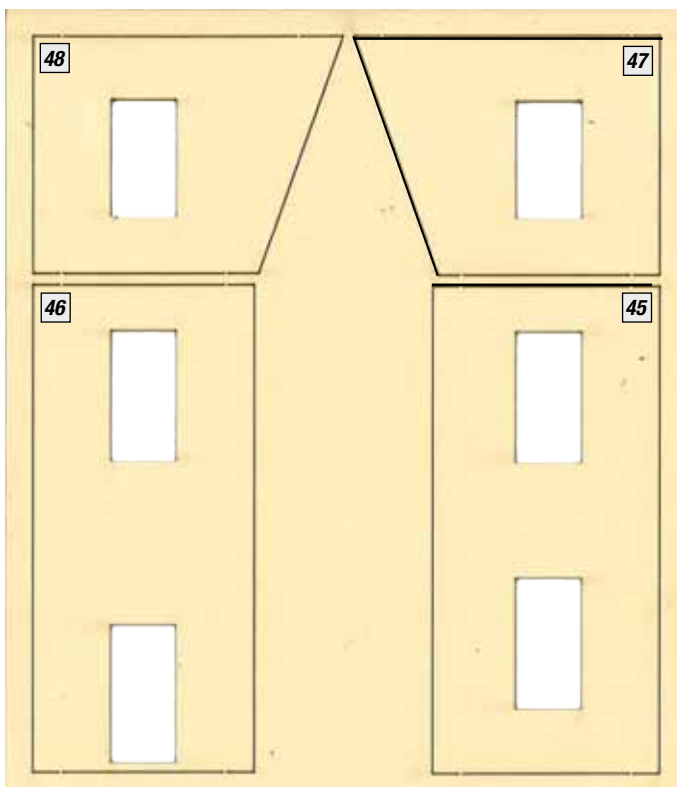
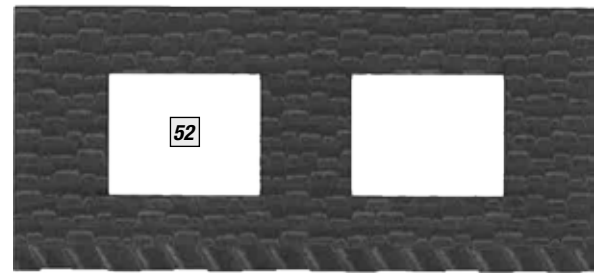
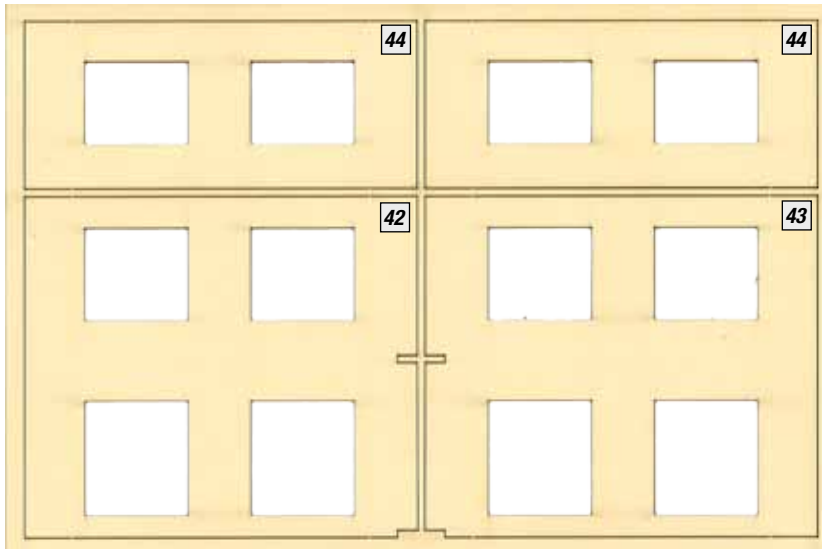
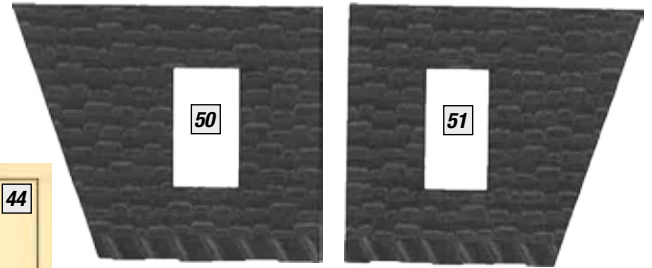
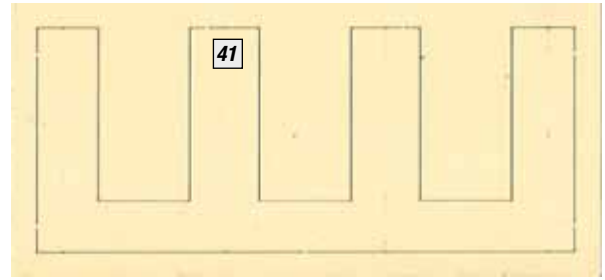
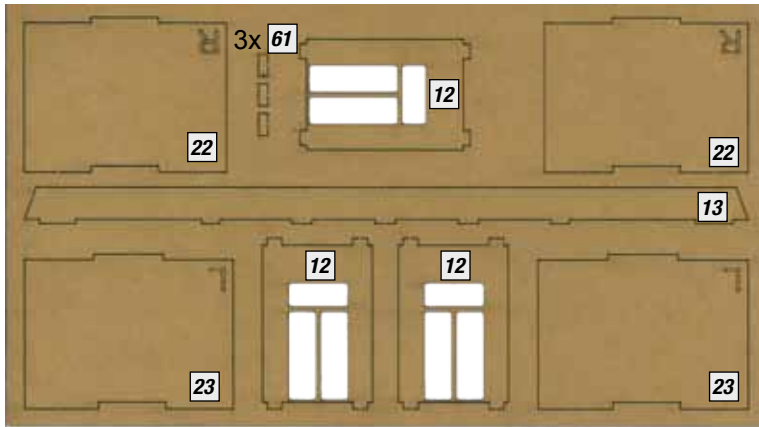

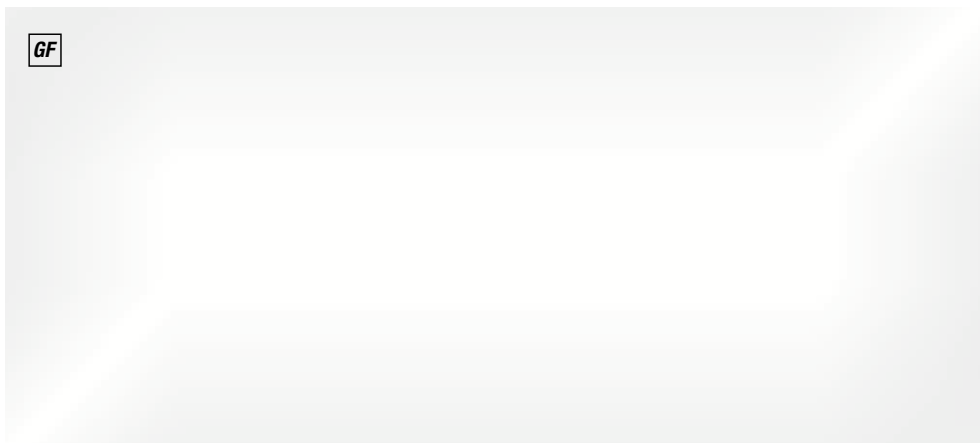
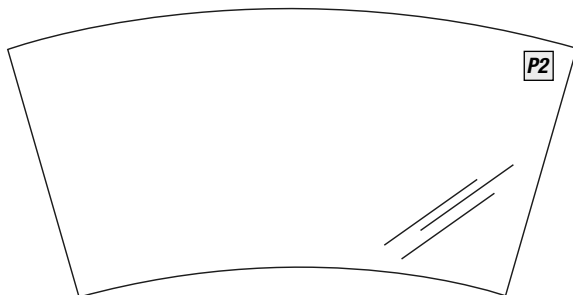
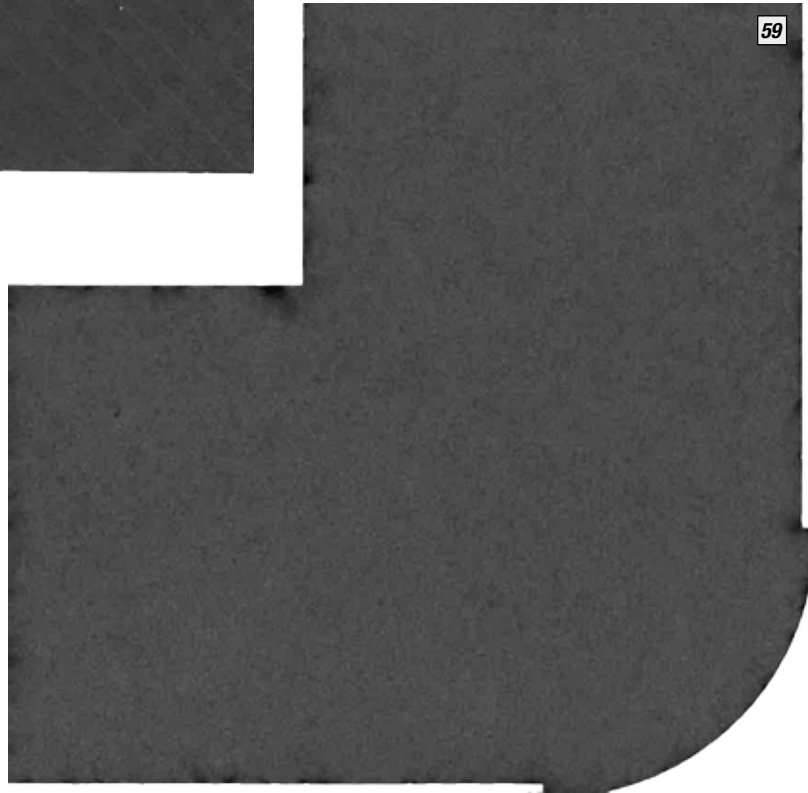

EDEN TABLE-DANCE-BAR EDEN 55

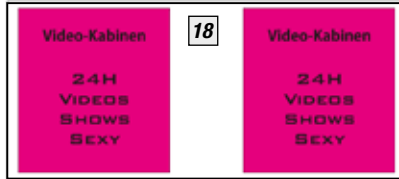
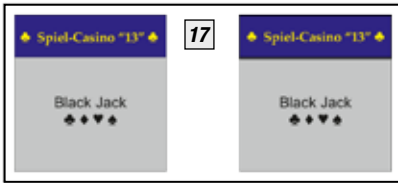

2x 62



Sex-Shop & Video-Kabinen 57

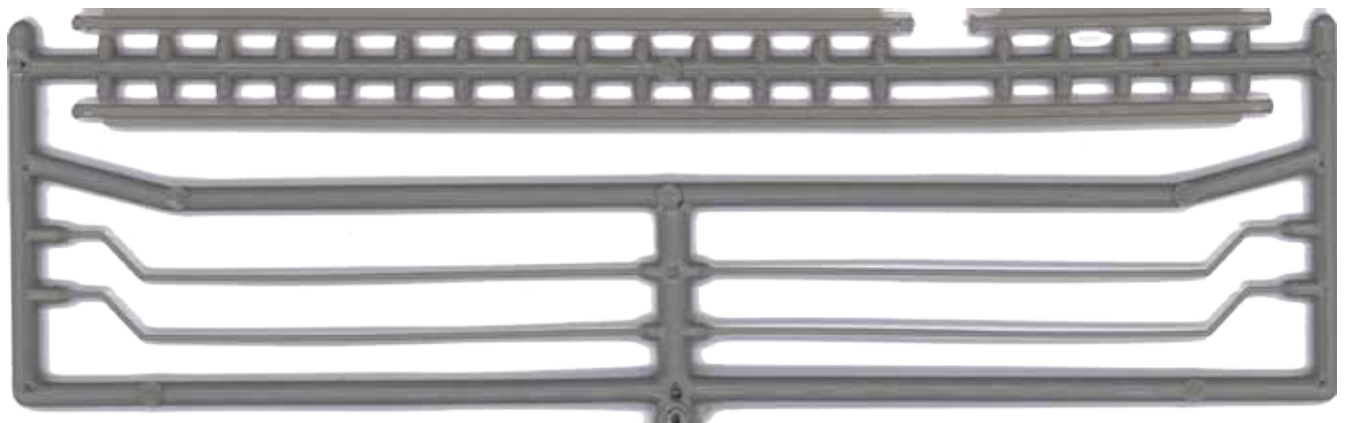
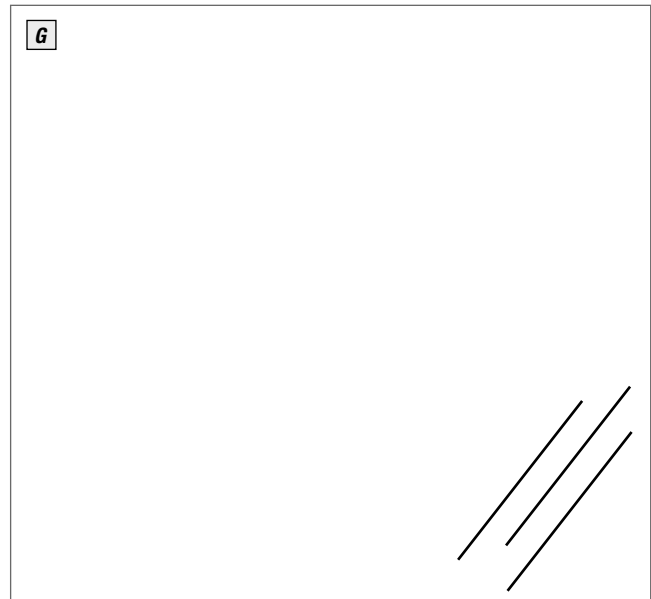
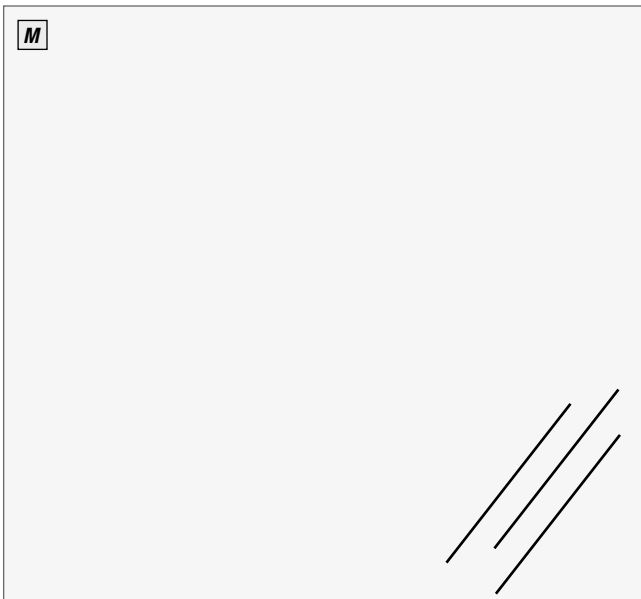

1.

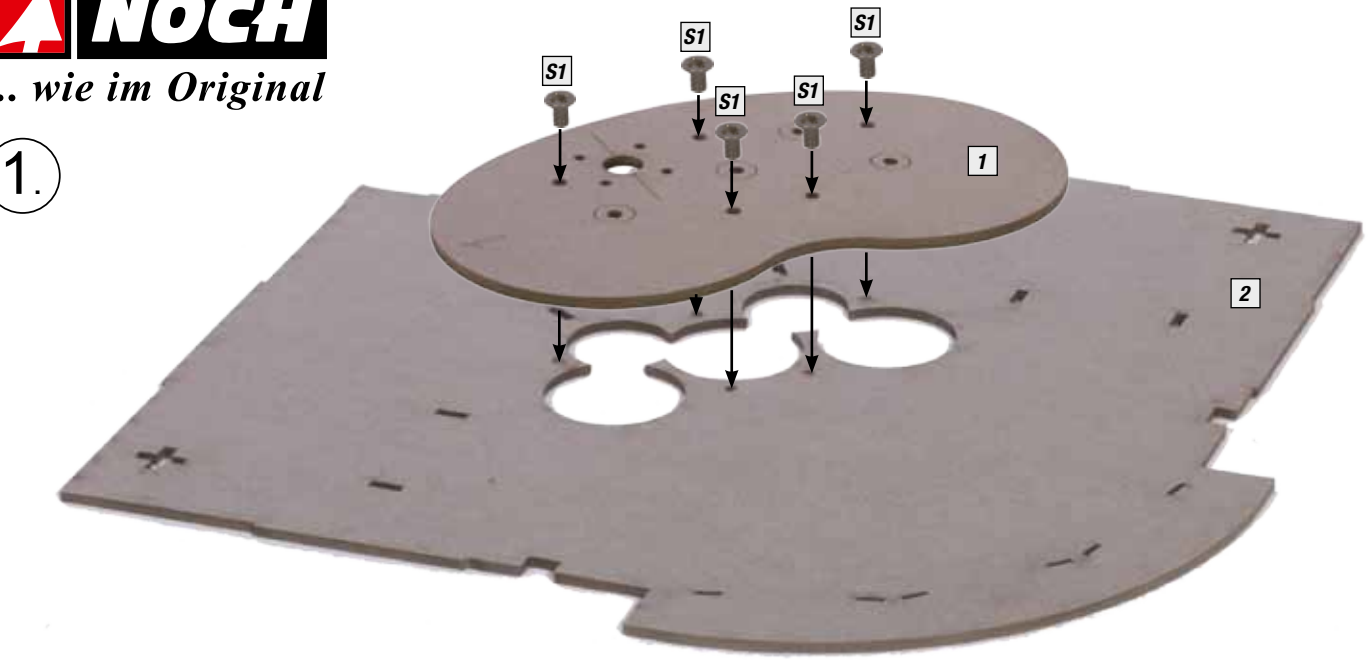

2.

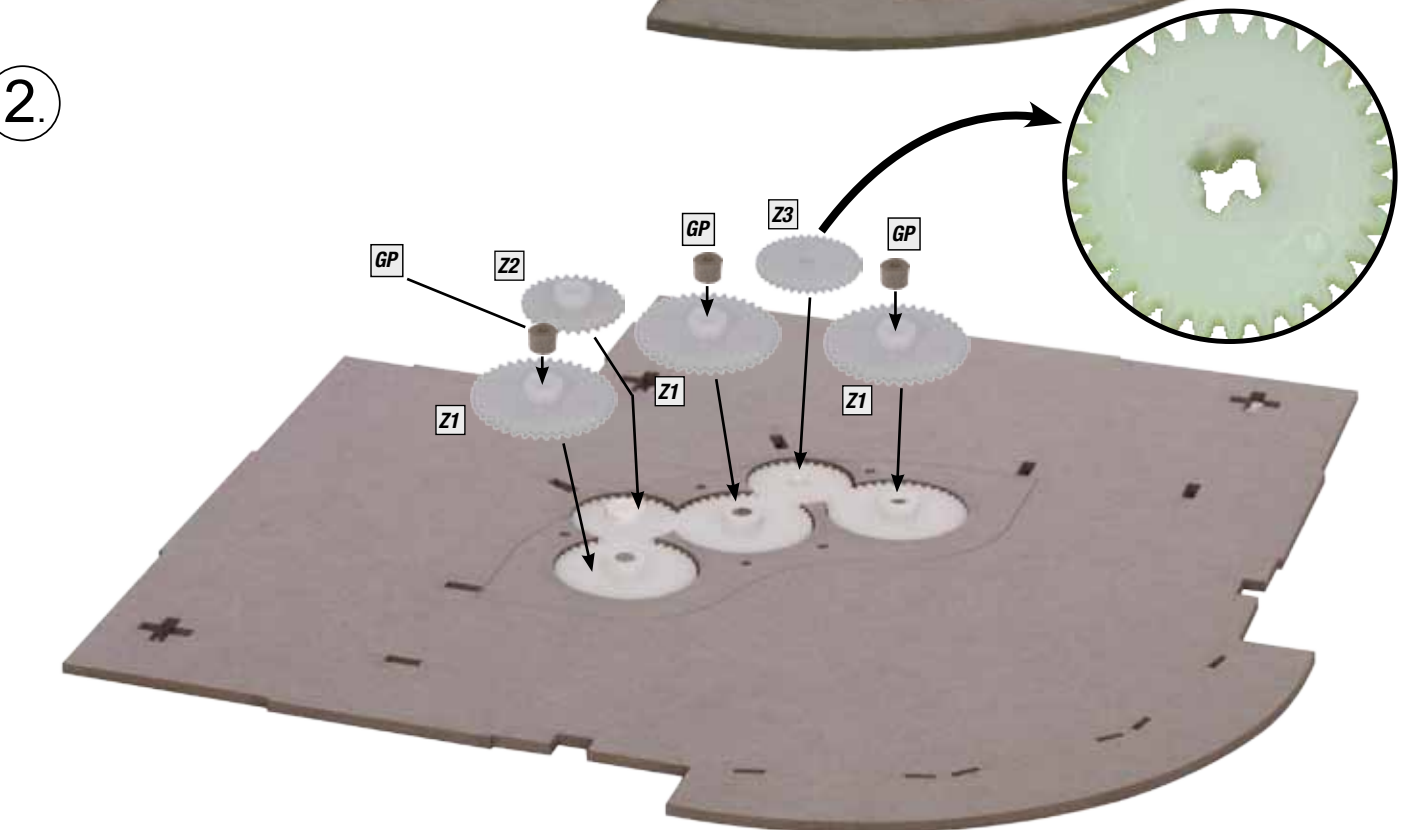

3.

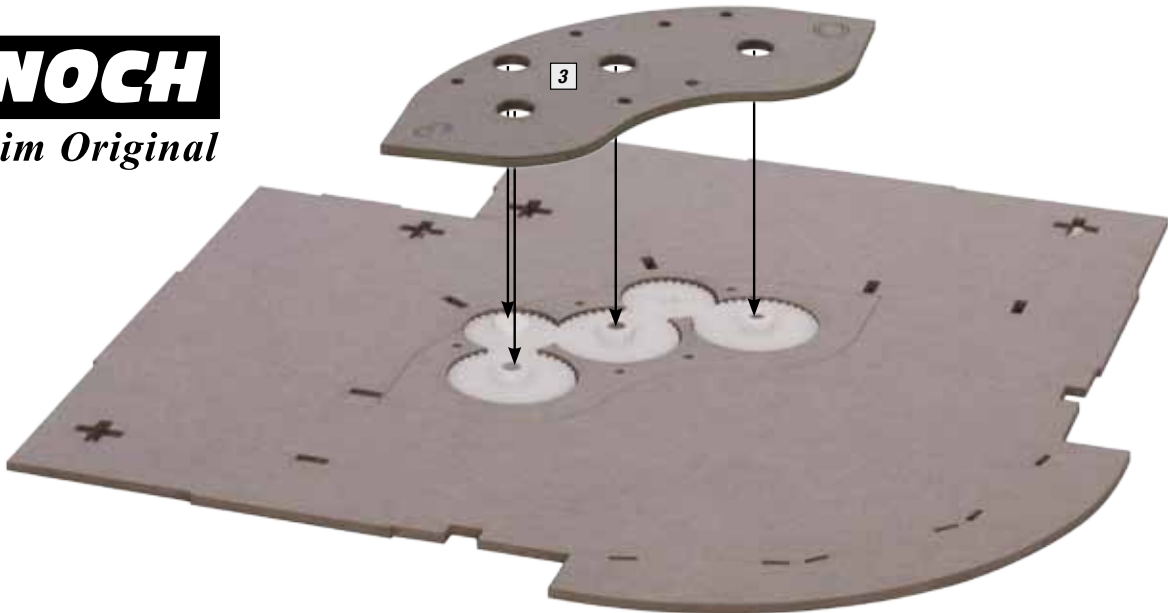

Achtung : Markierung beachten ! Kein Kleber ins Getriebe bringen !

Attention : Check Marks ! Don't glue the gear unit!

4.

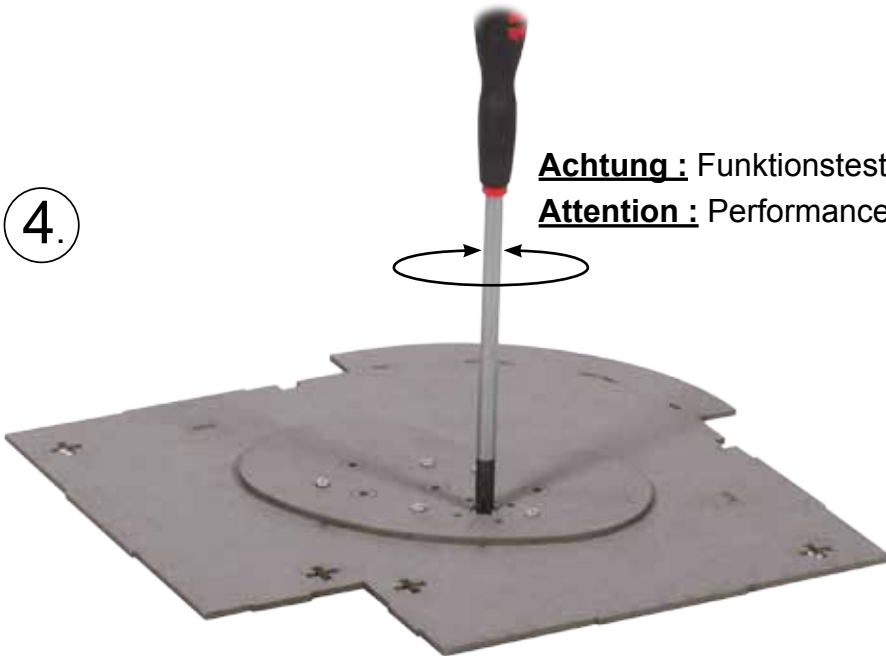

Achtung : Funktionstest ! Es muss sich leicht drehen lassen !

Attention : Performance check ! A lightly turning is important !

5.

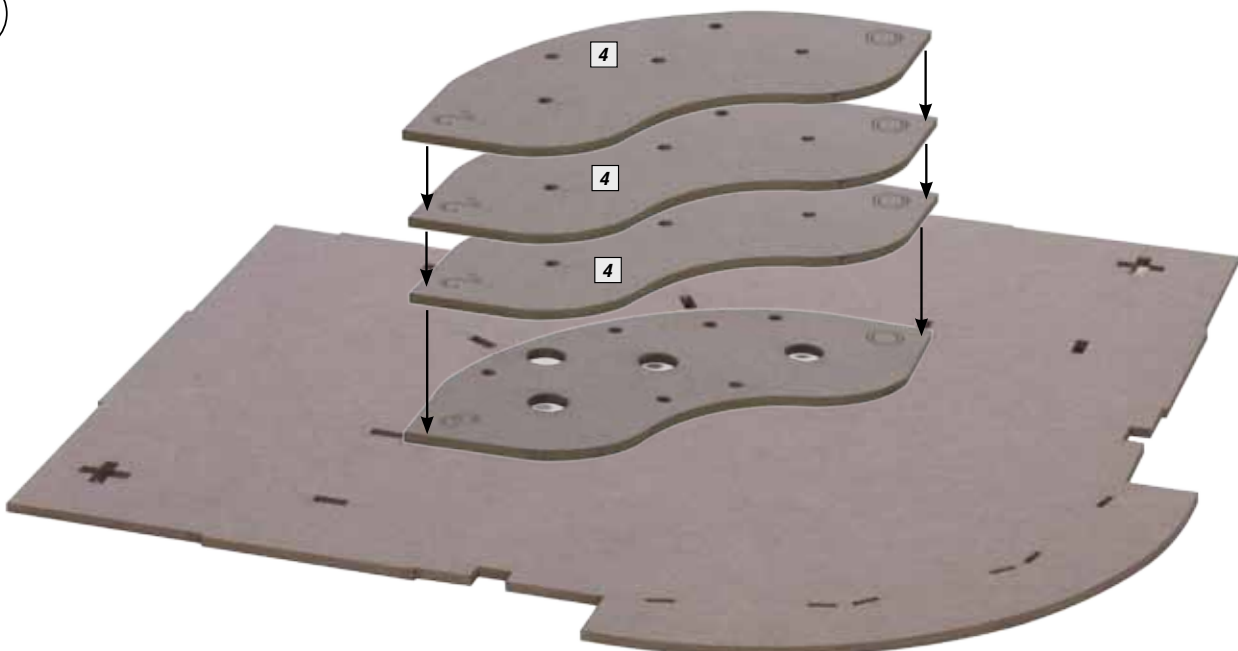

6.

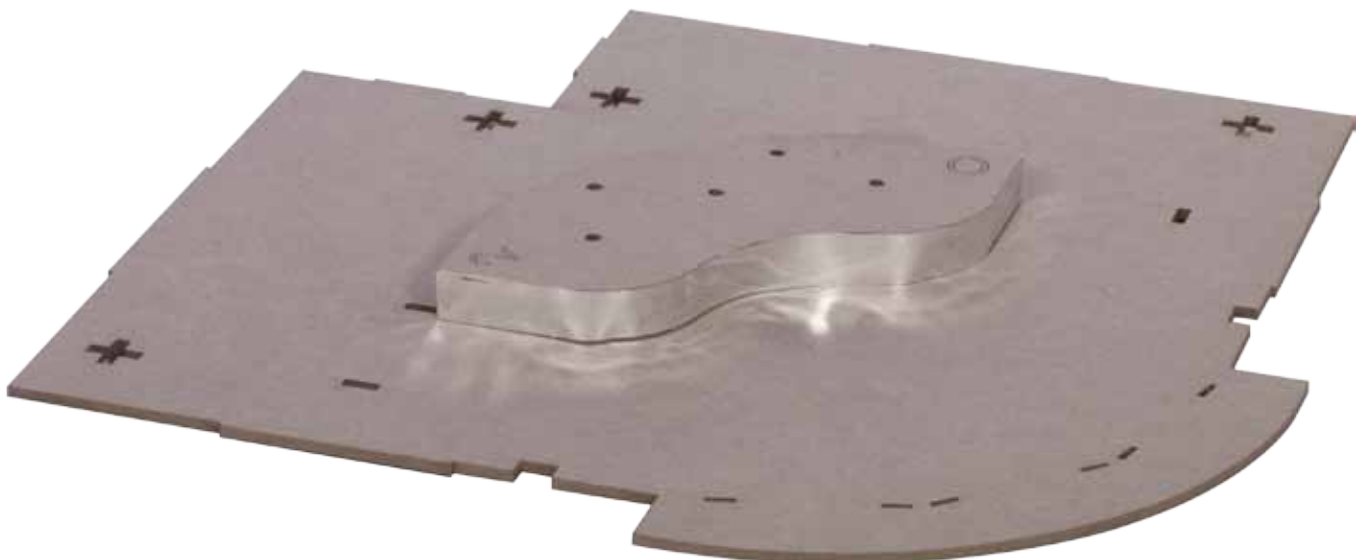
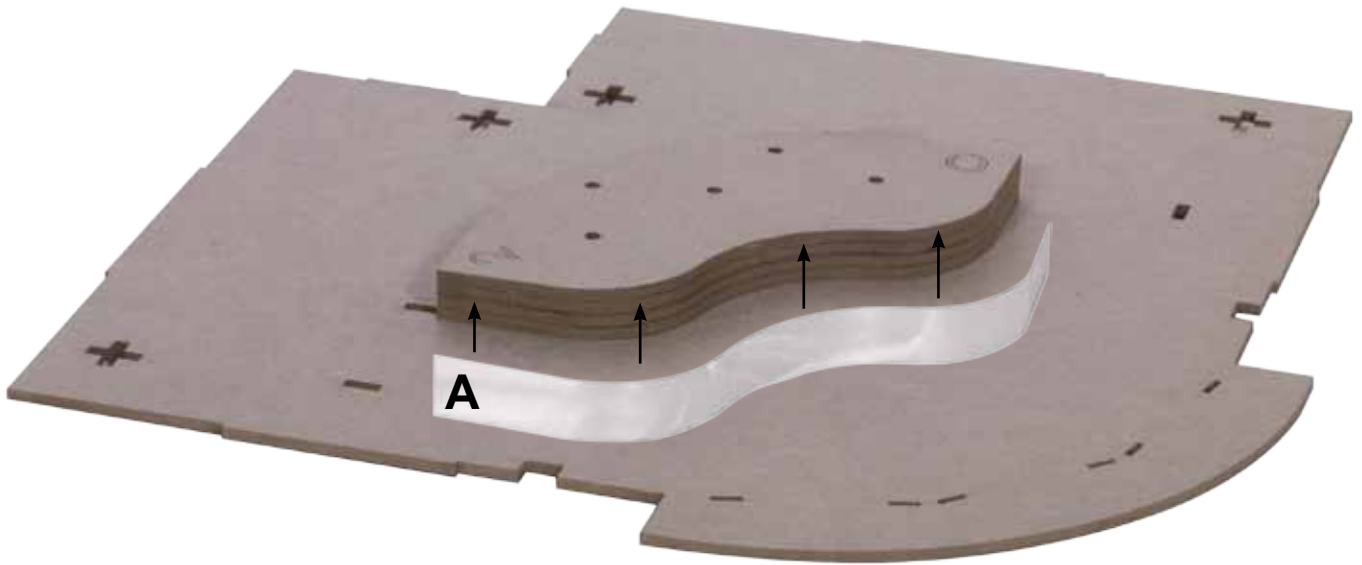
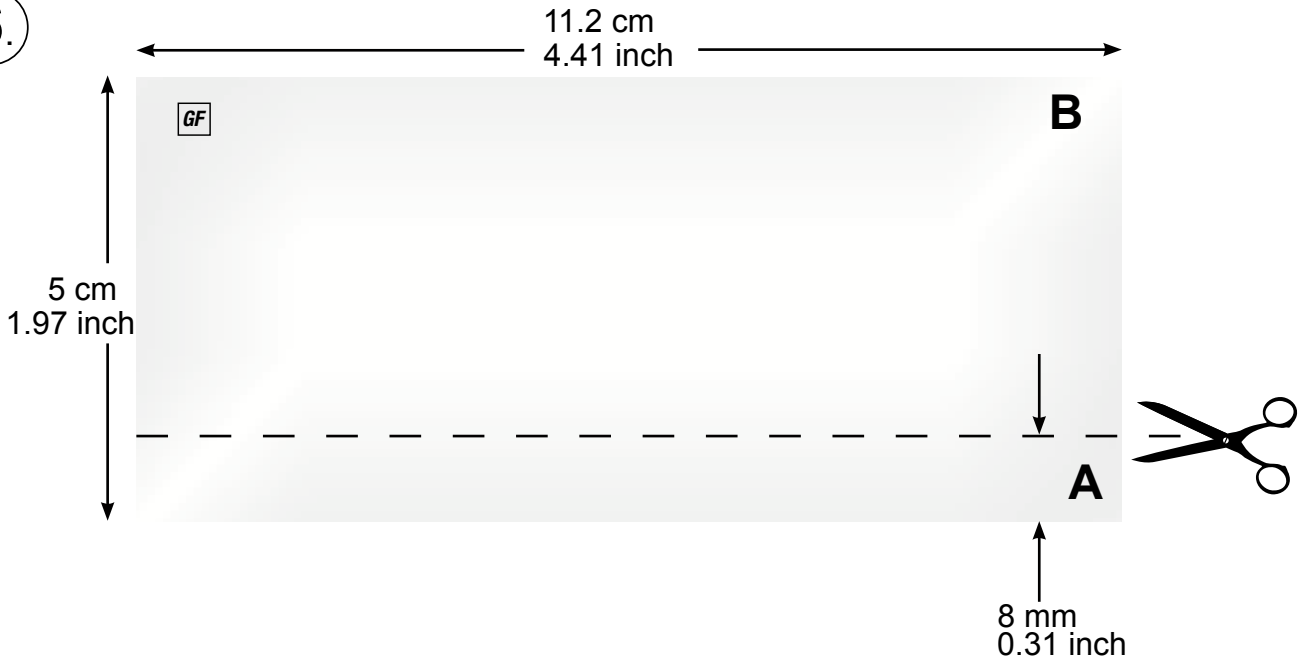

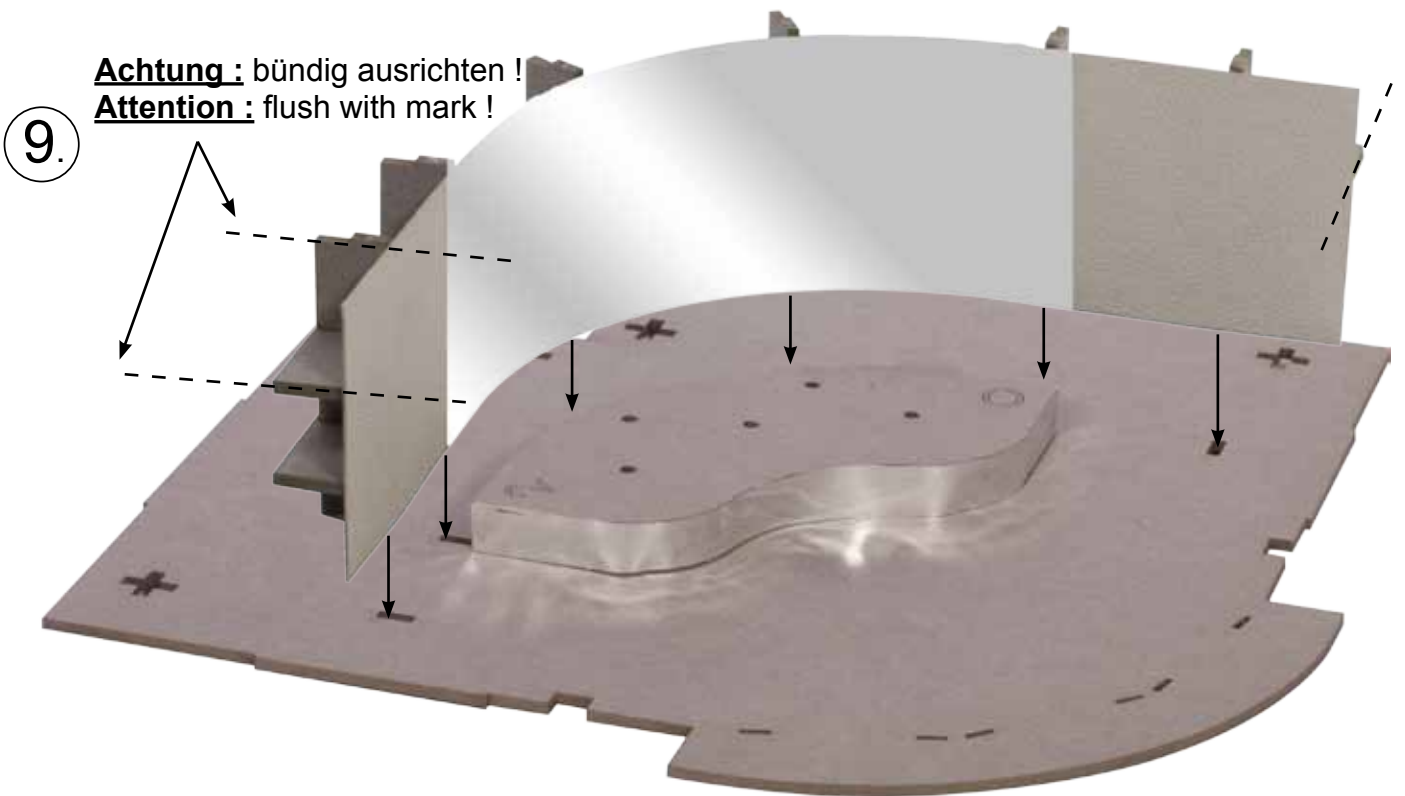
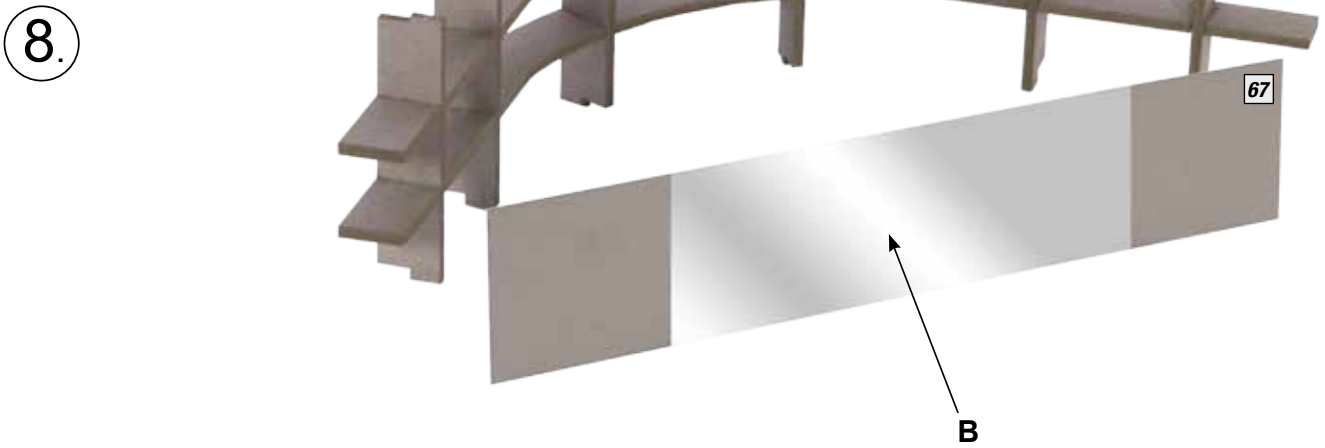
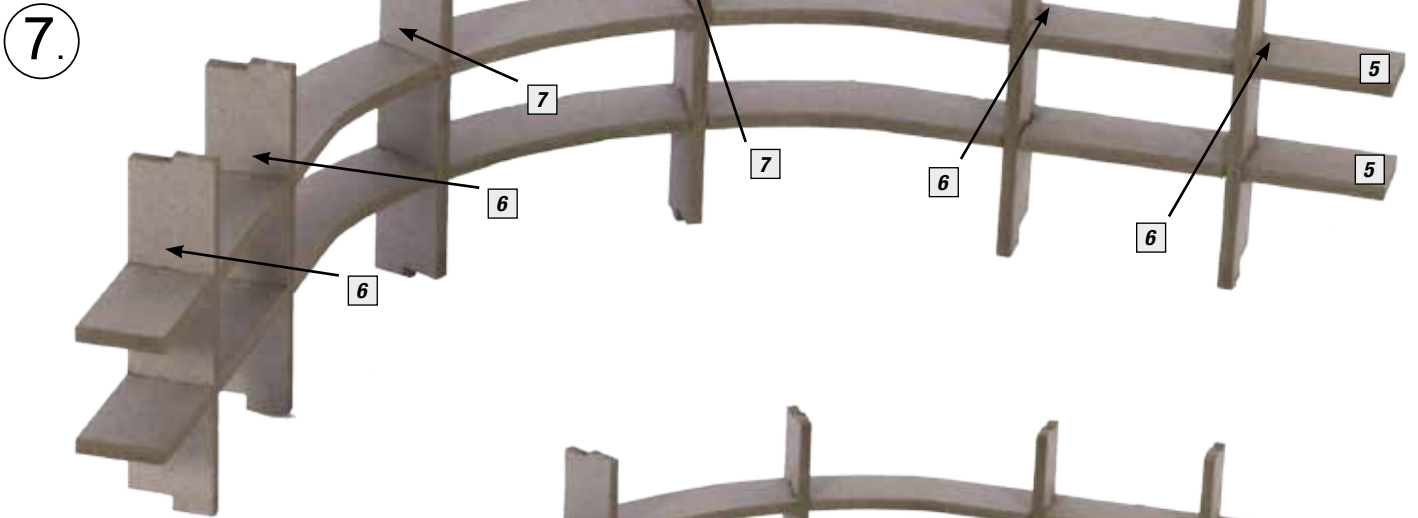

10.

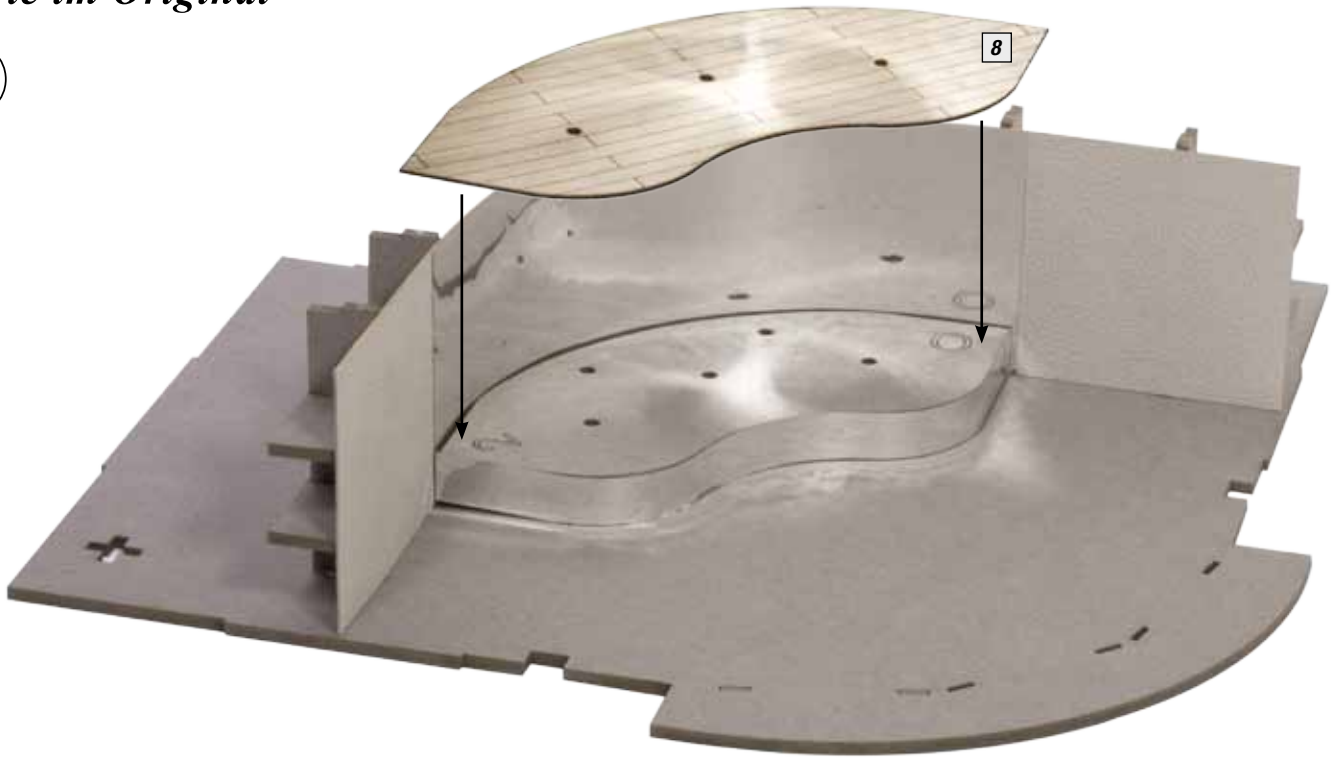

11.

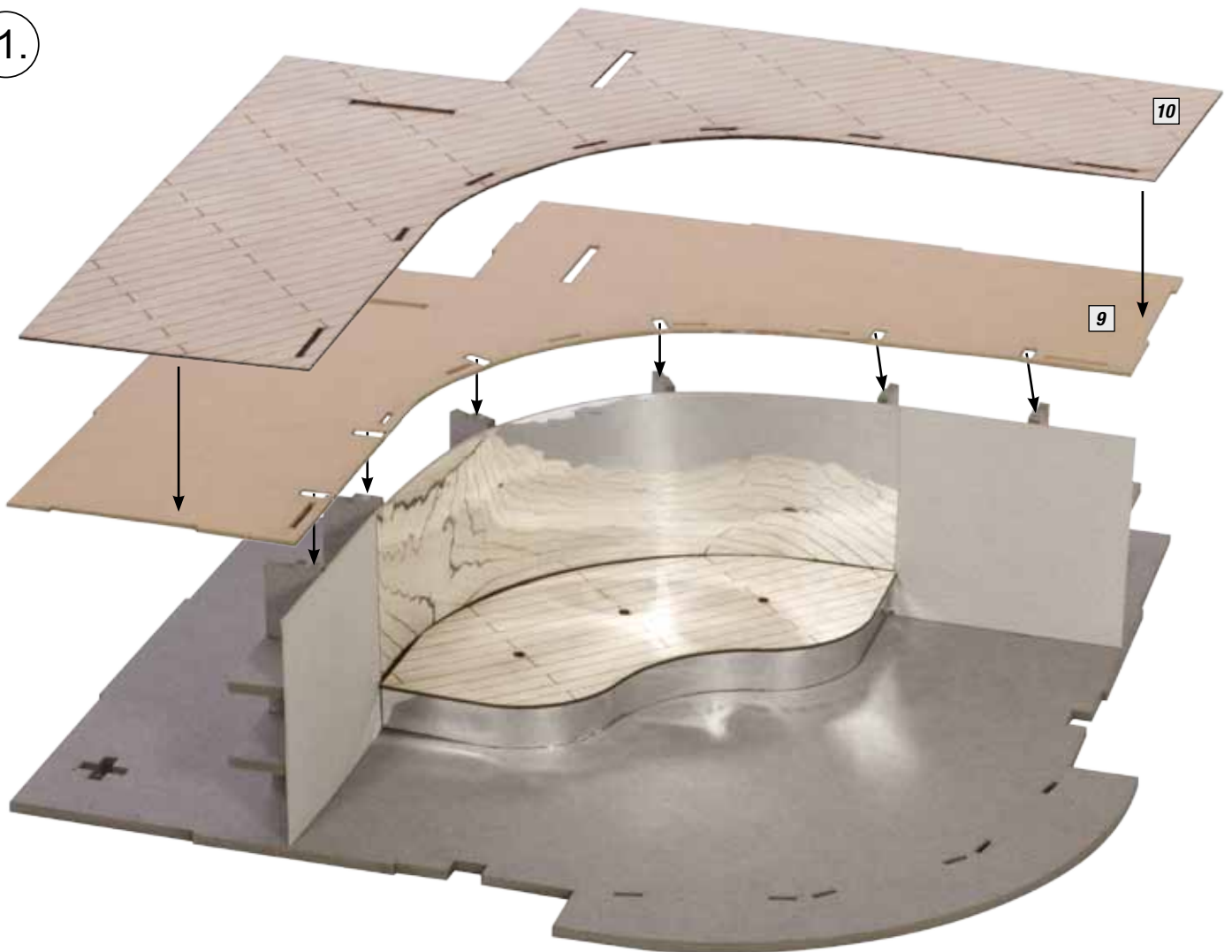

12.

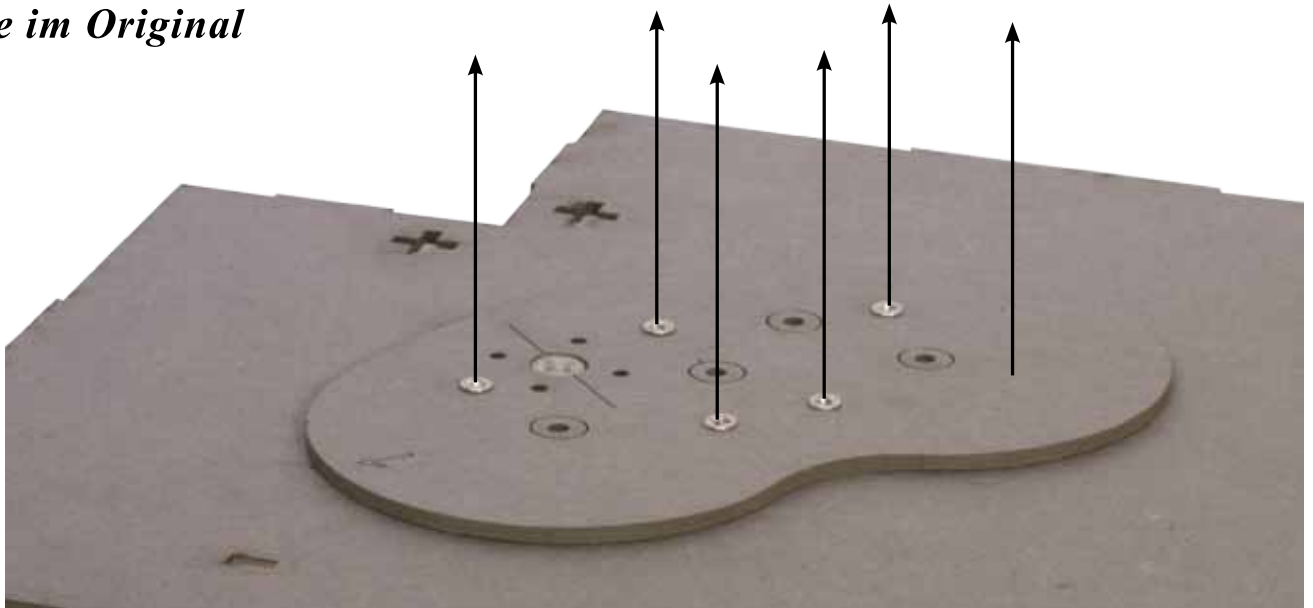

13.



14.

Achtung : Stange vorsichtig in Gummi -
pfropfen stecken !

Attention : Stick bar careful in rubber cork !

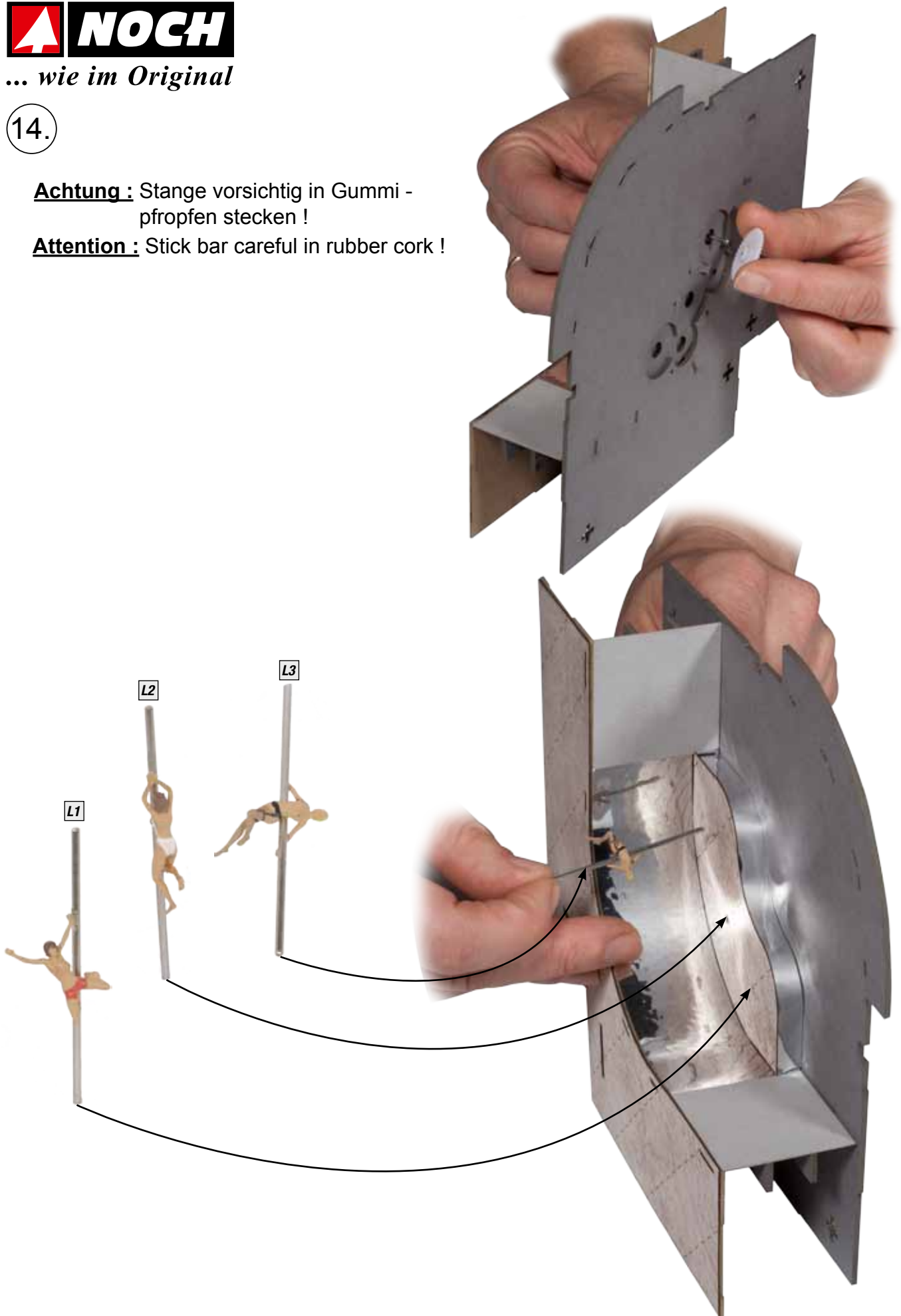

15.

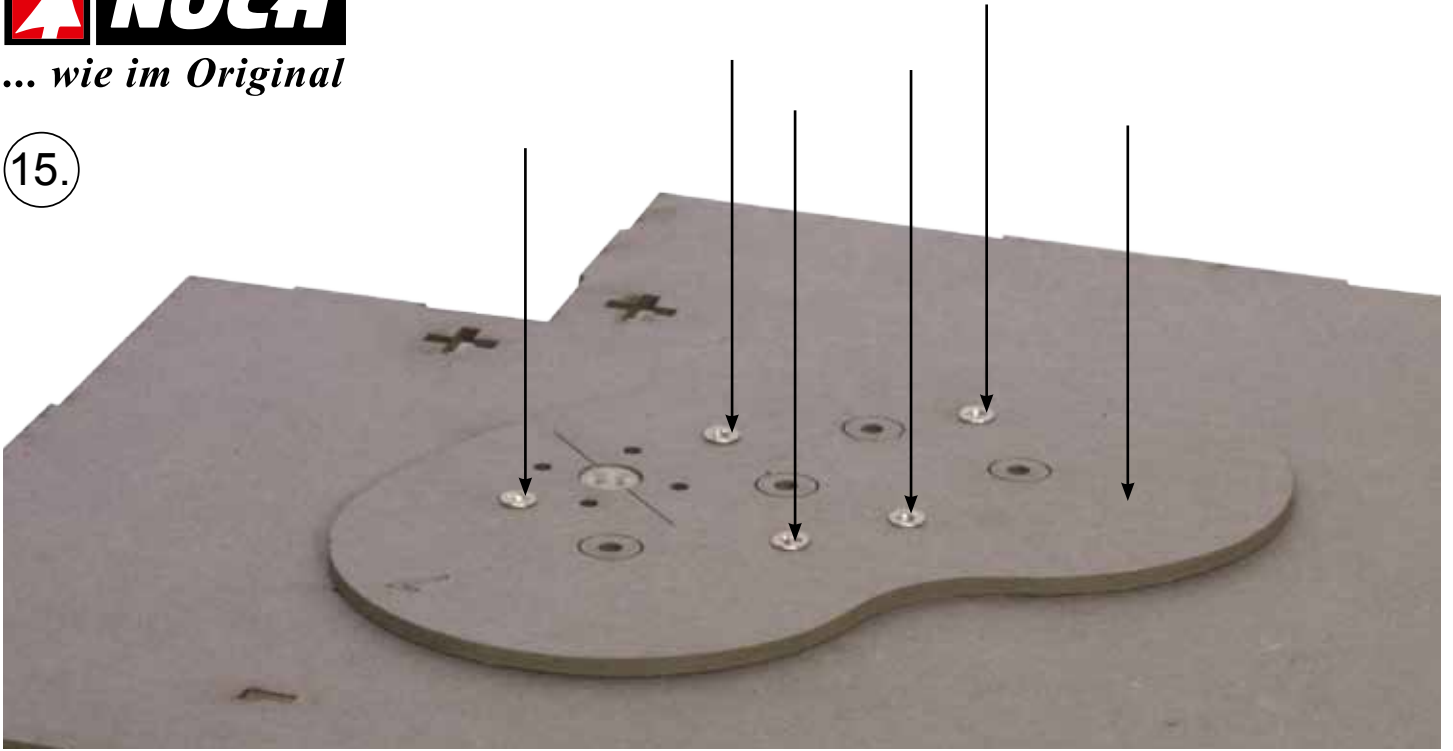

Achtung : Funktionstest ! Es muss sich leicht drehen lassen !

Attention : Performance check ! A lightly turning is important !

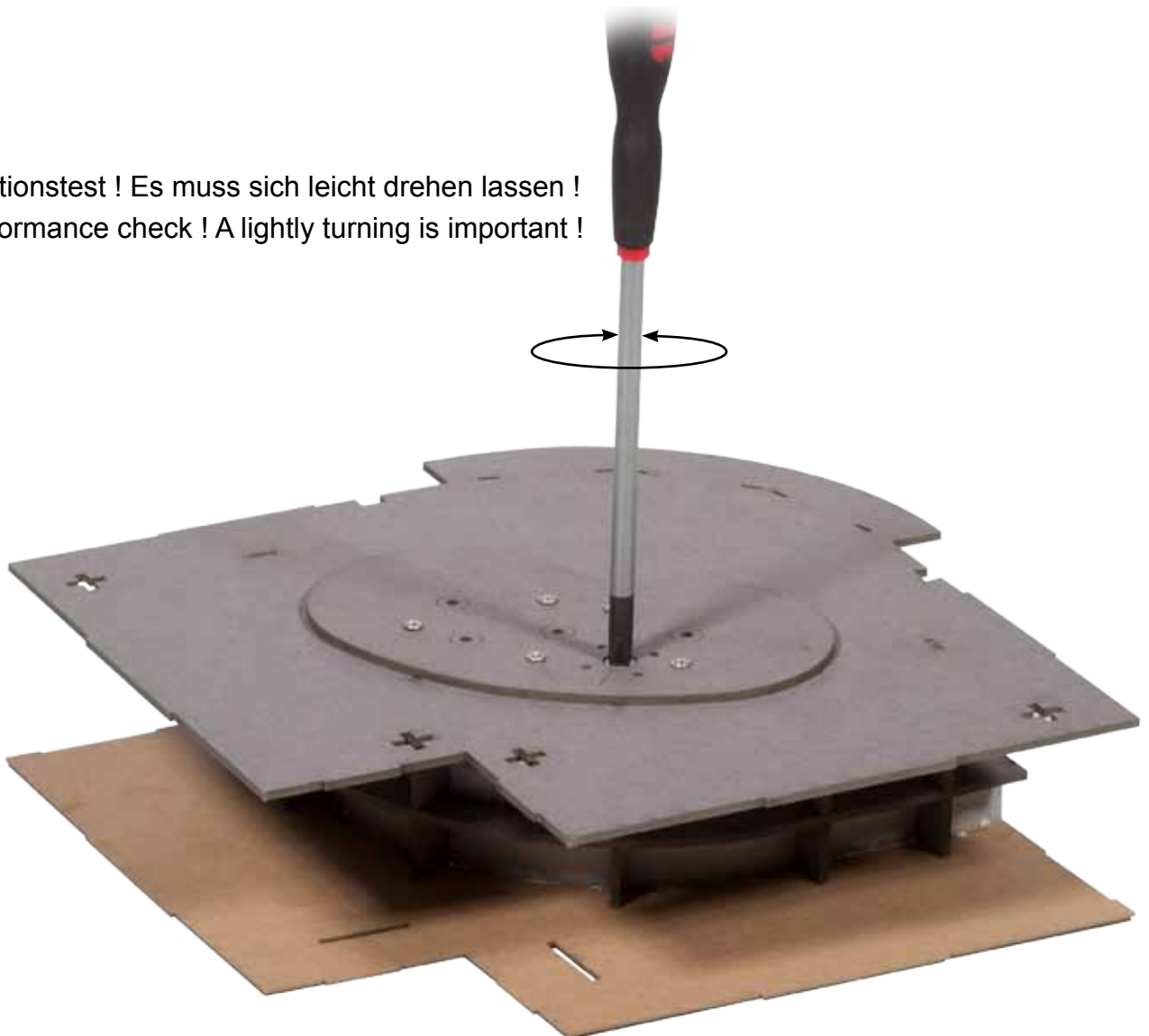



16.

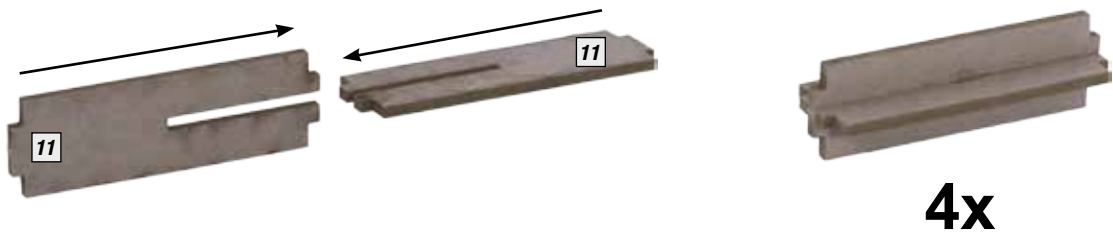

17.

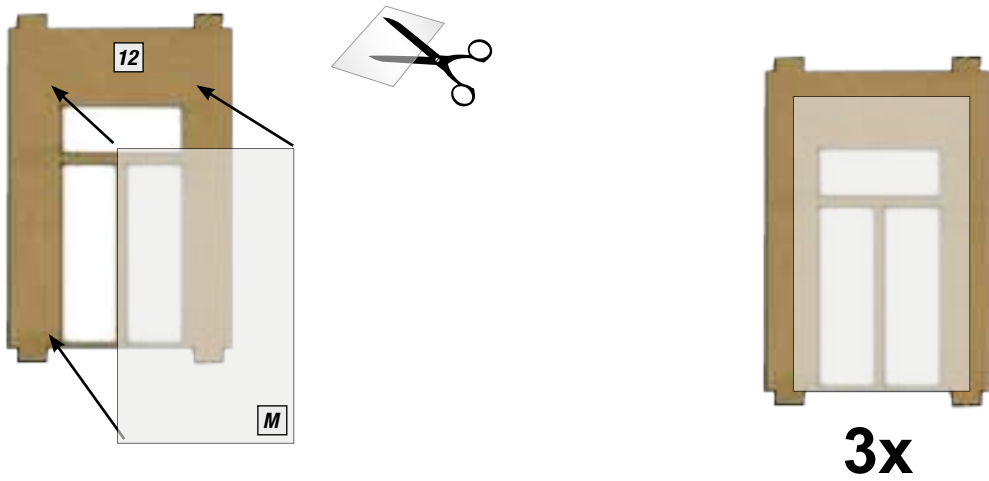

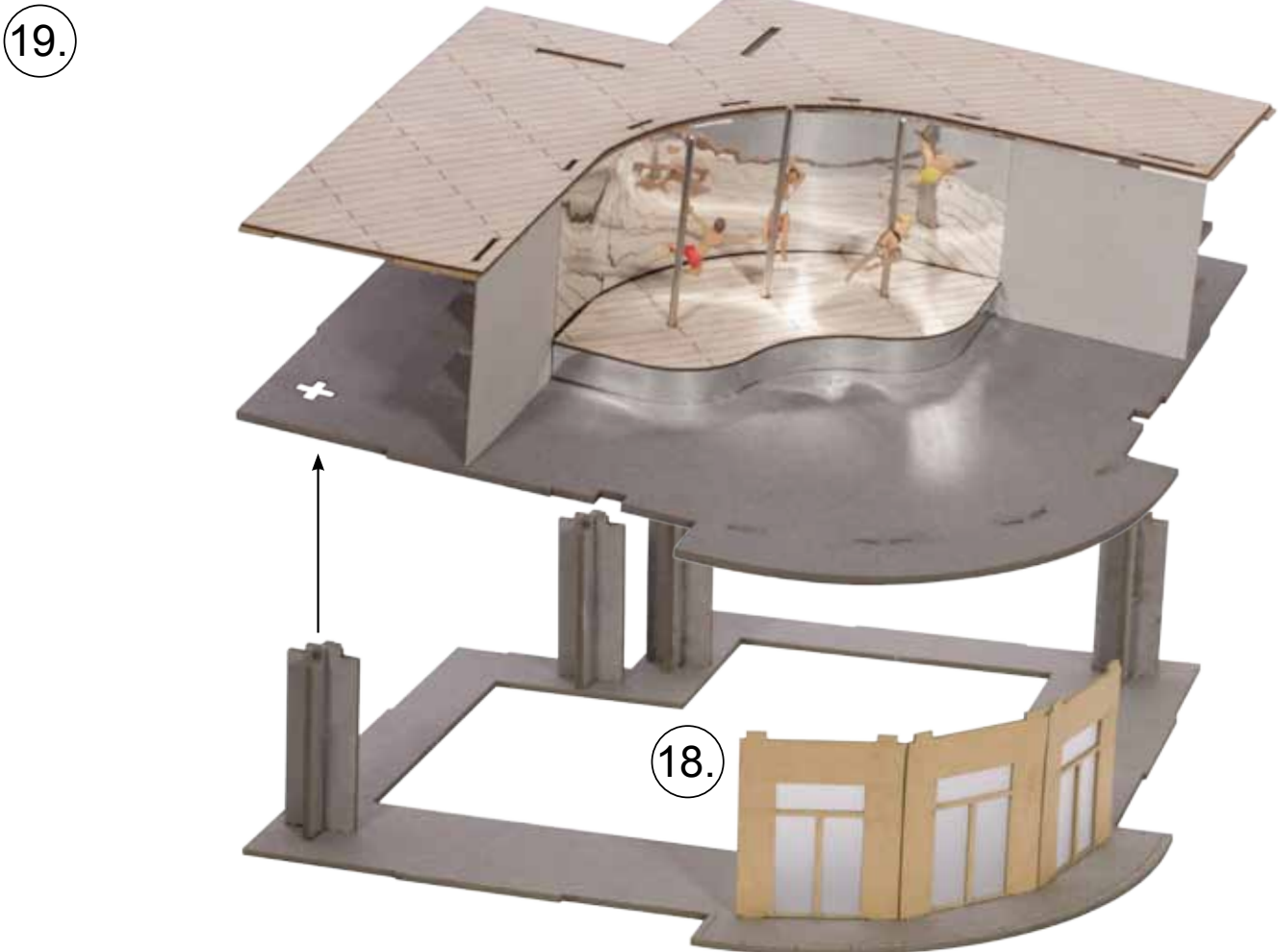
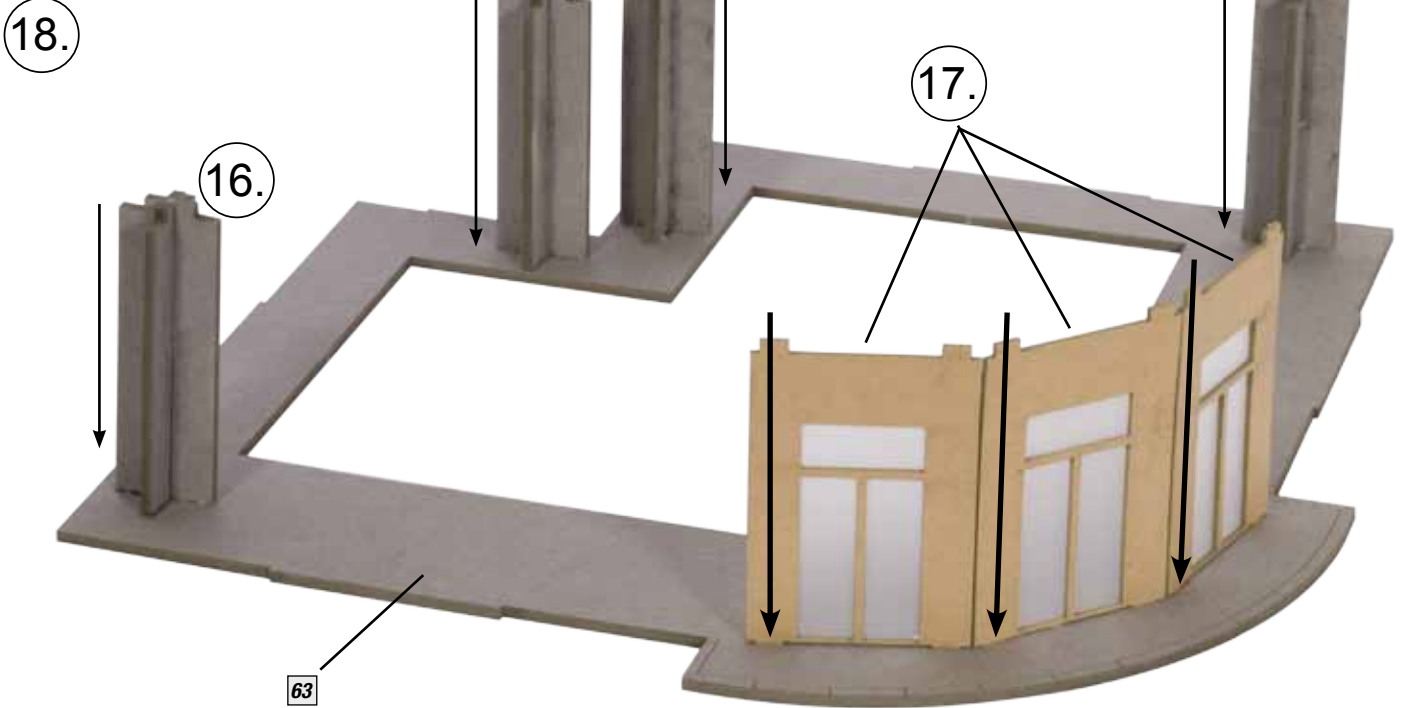

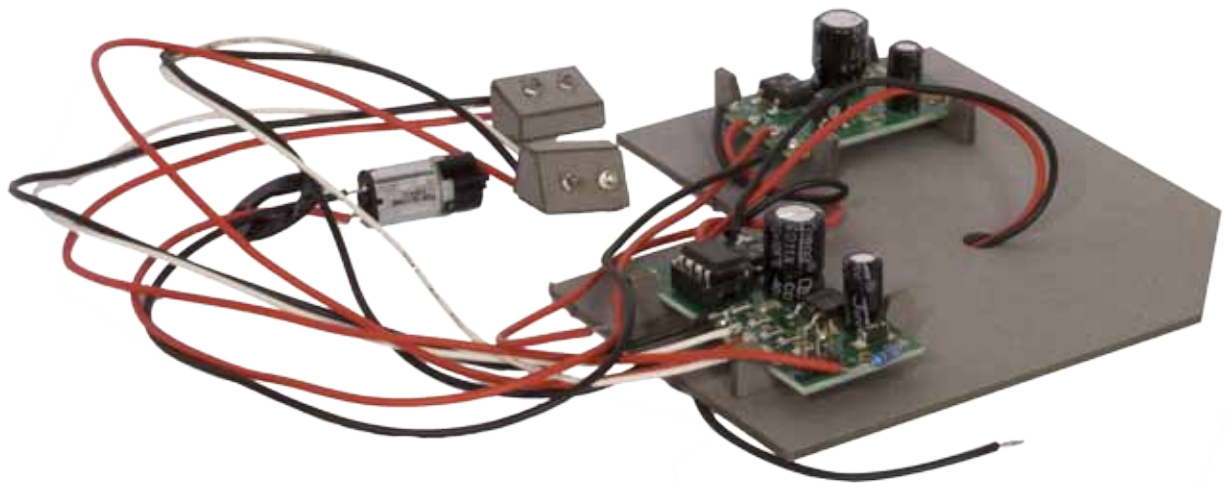

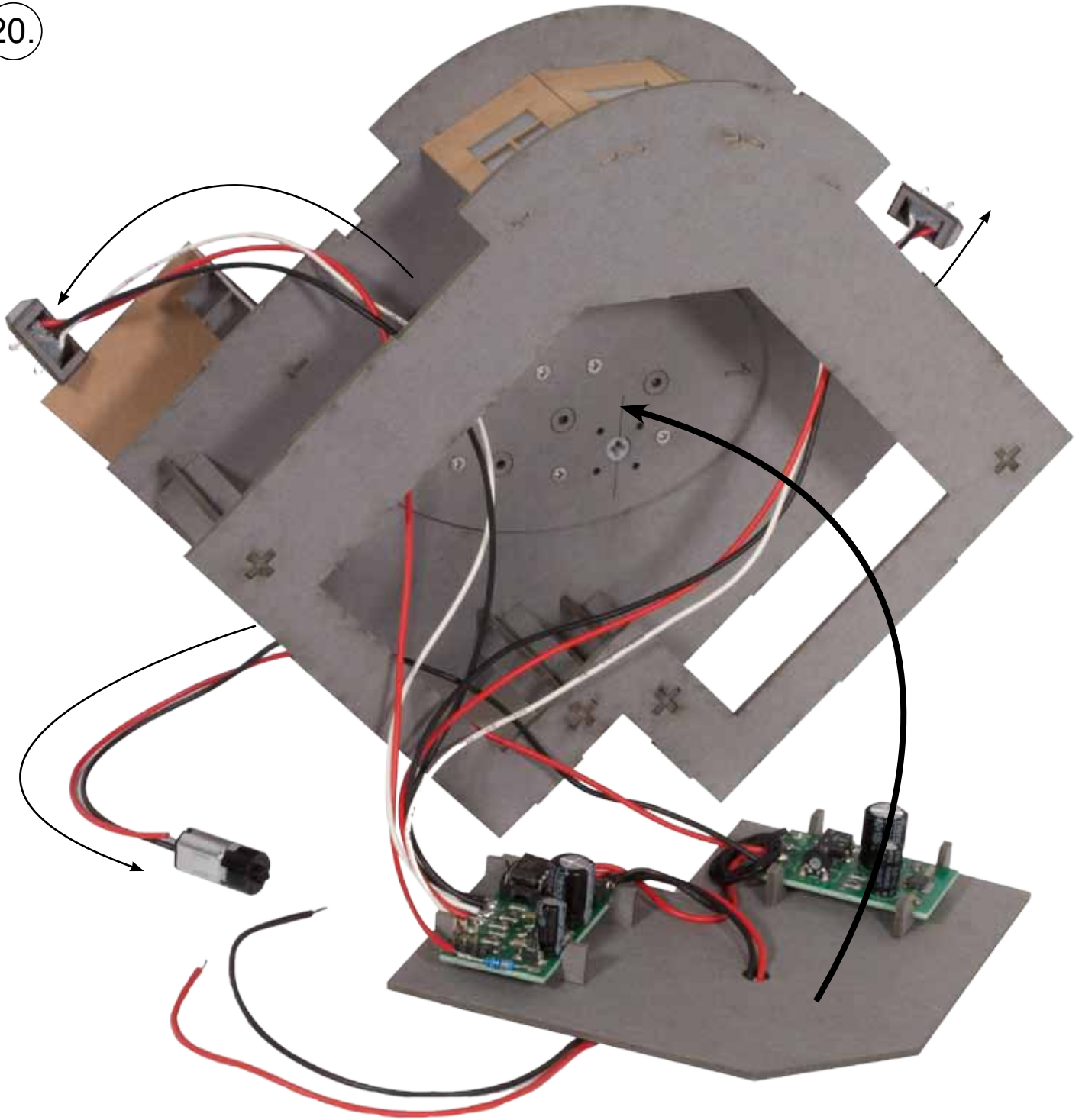

21.

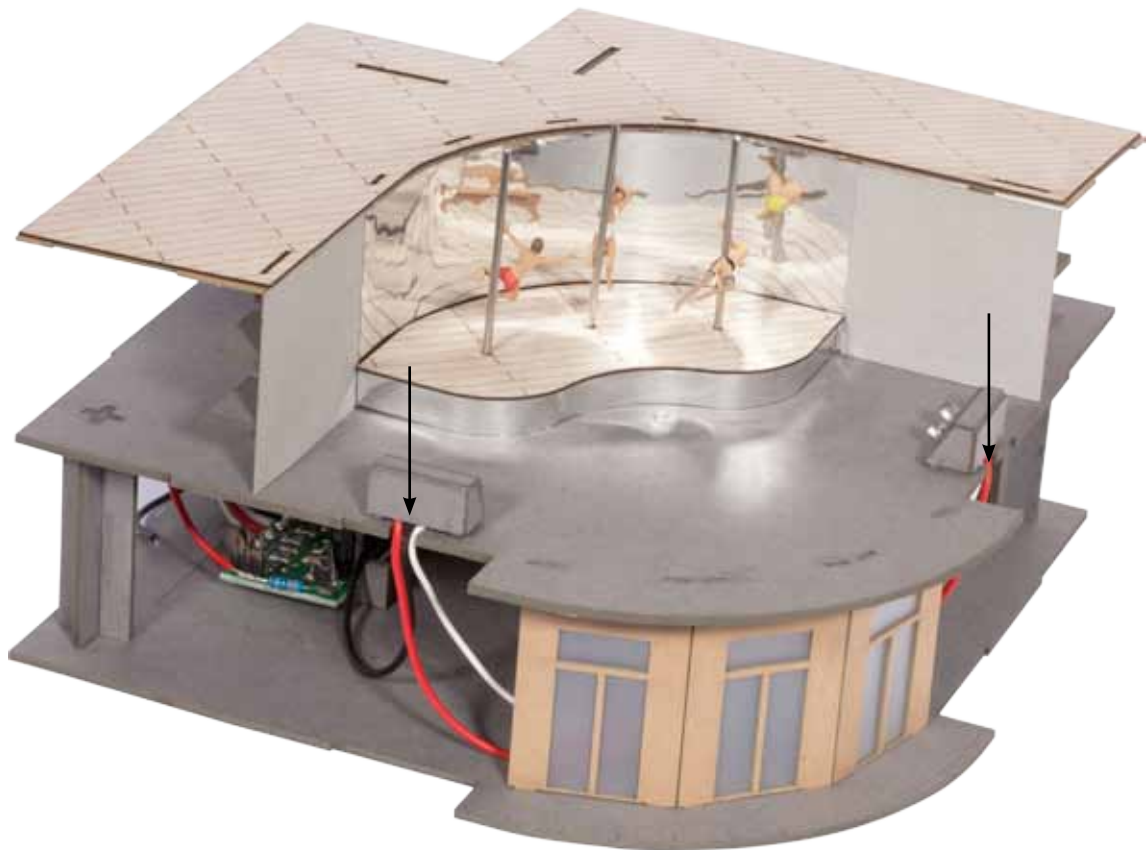

22.

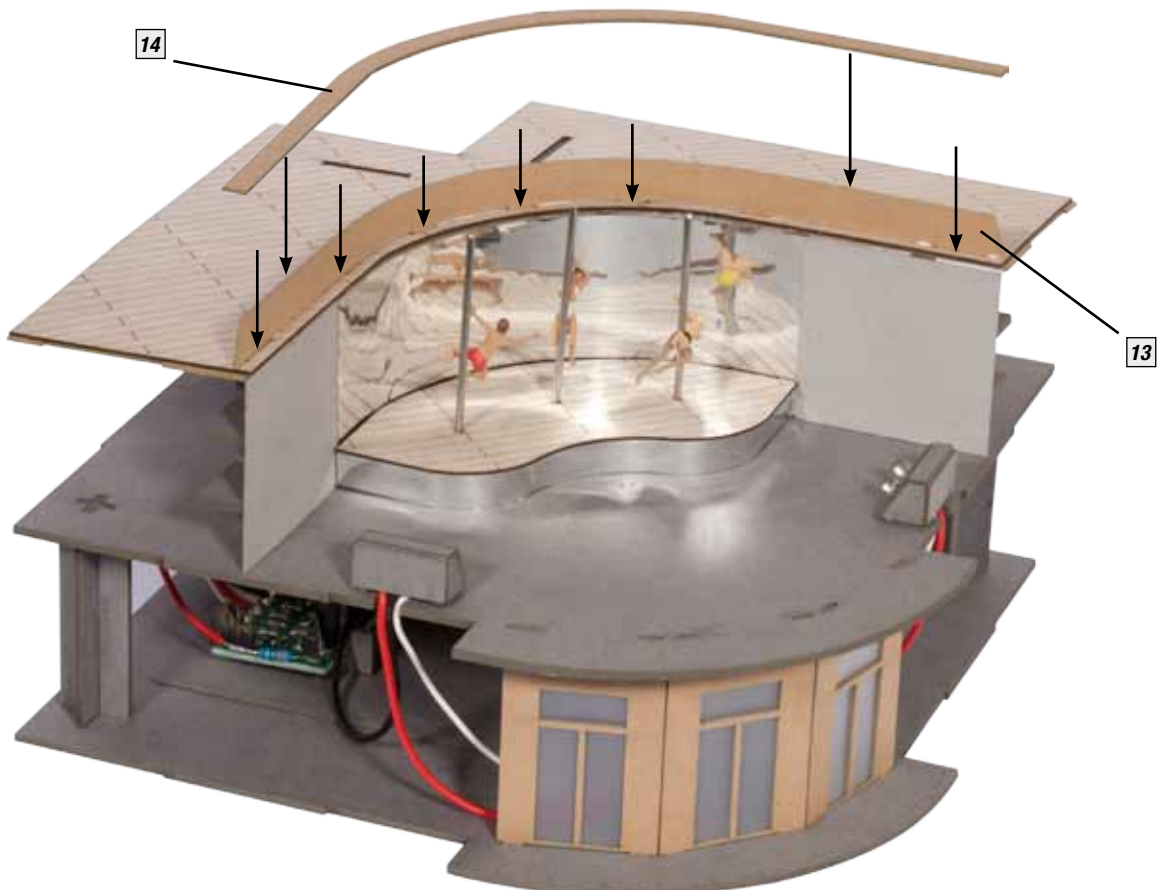



23.

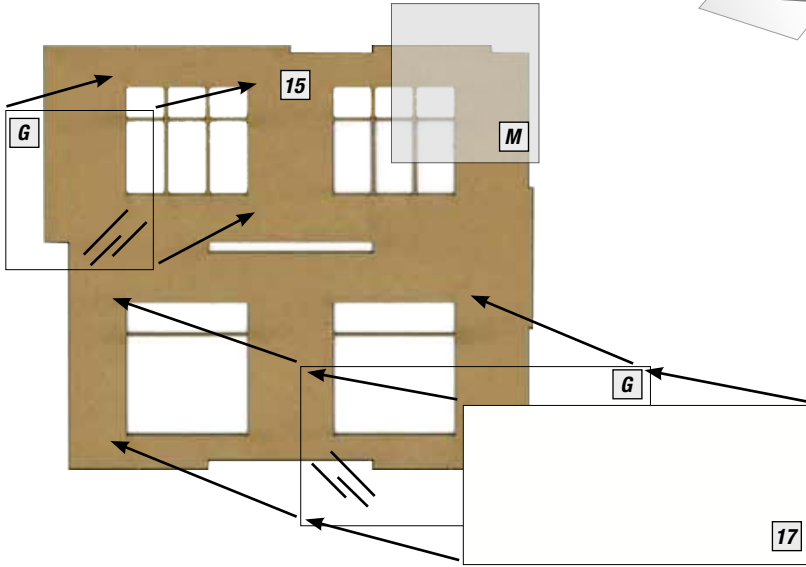

24.

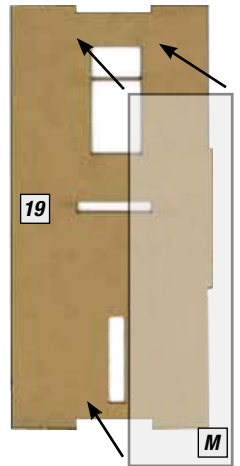

25.

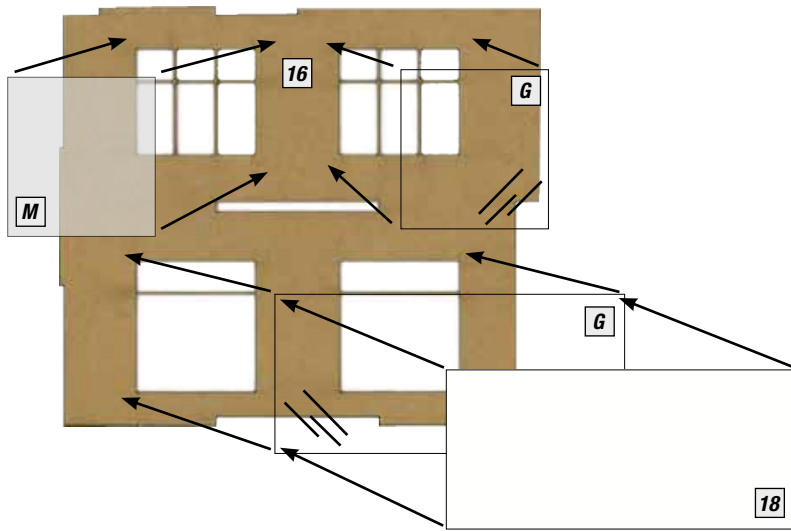

26.

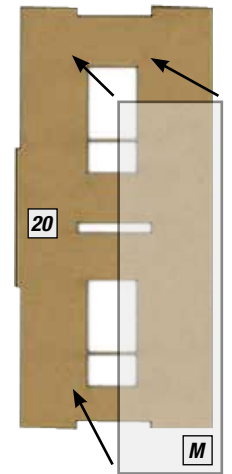

23.



25.

27.

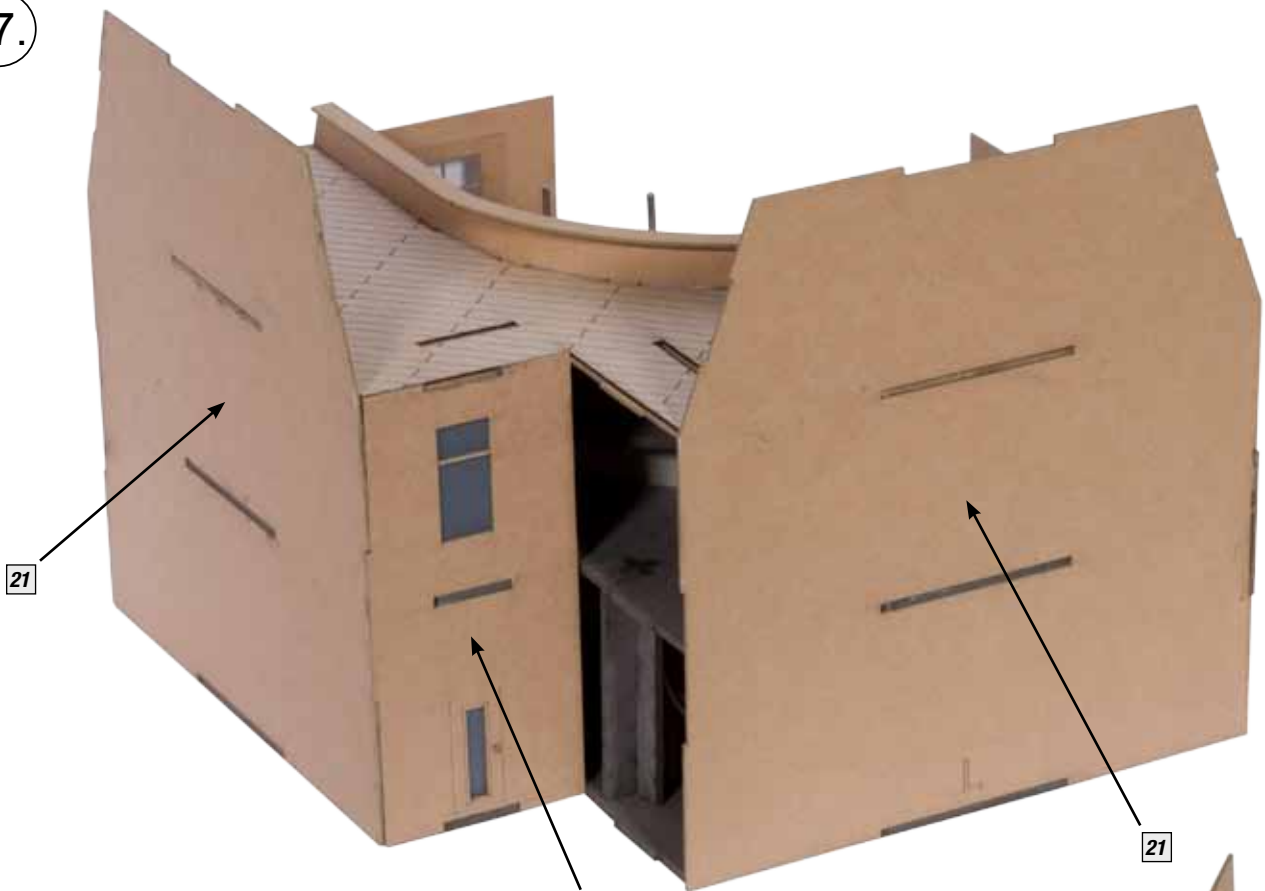

28.

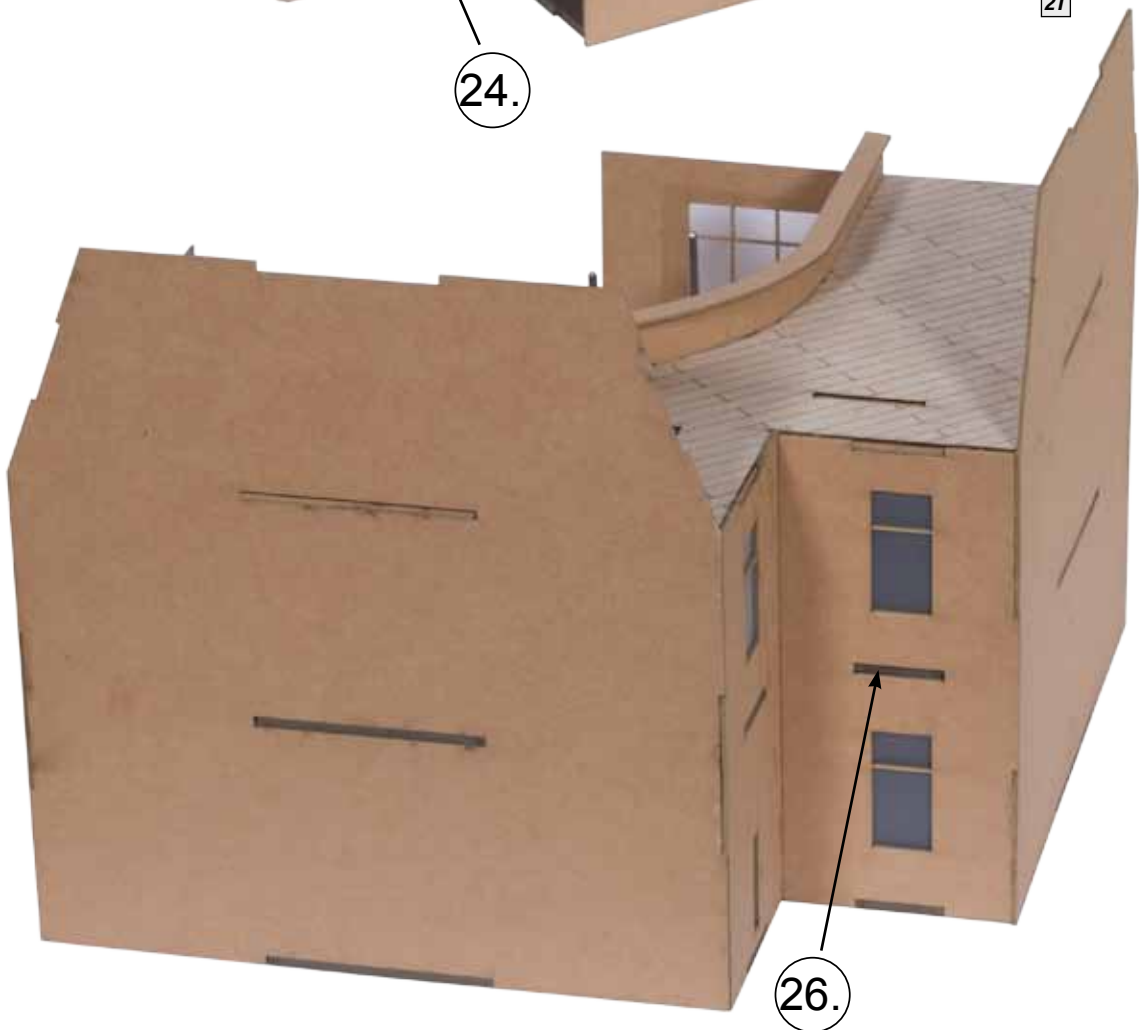

29.

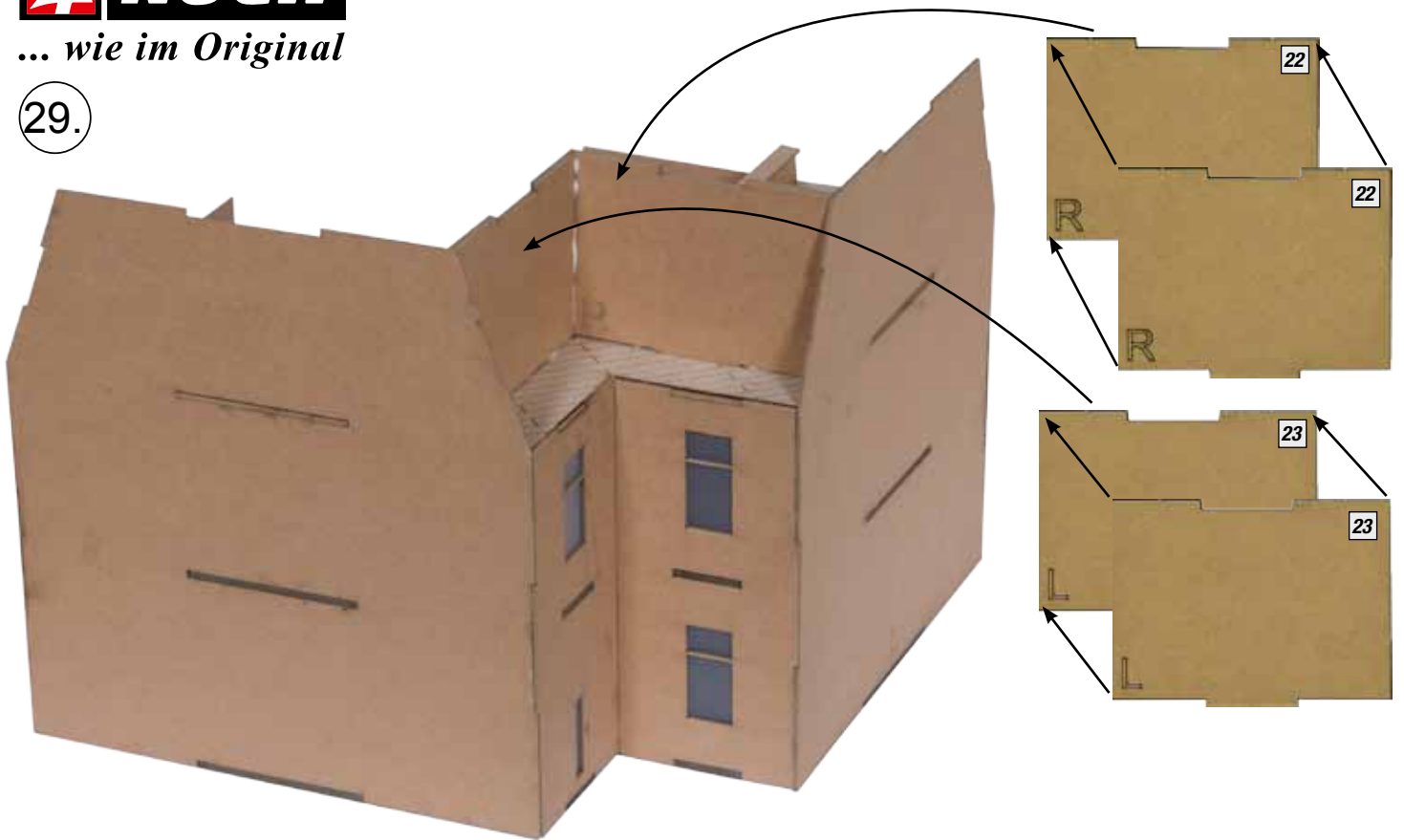

30.

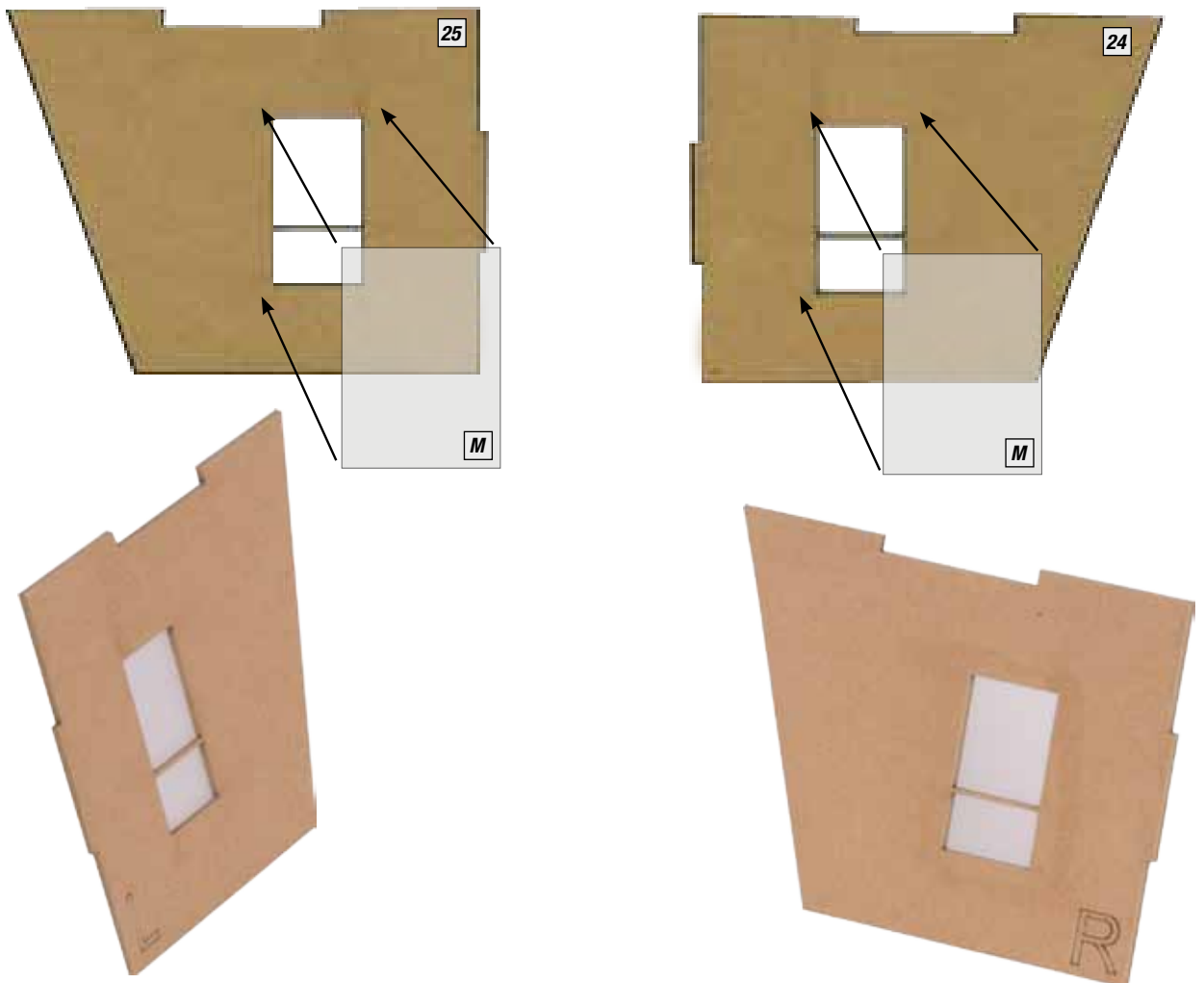

31.

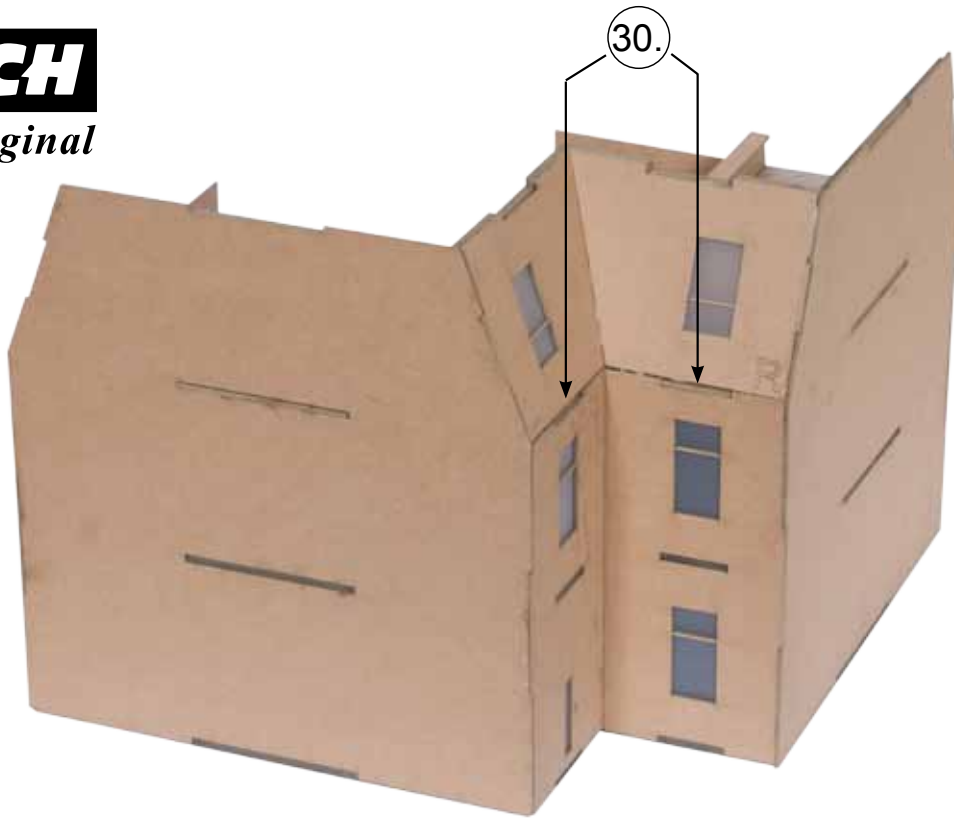

32.

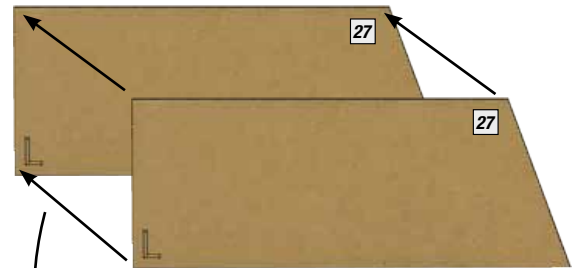
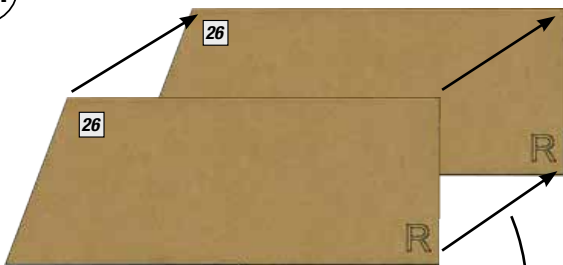

33.

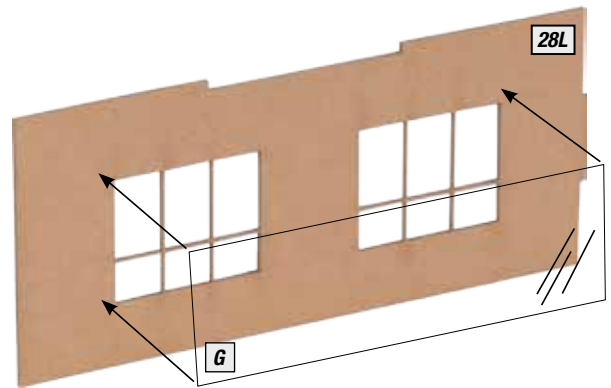
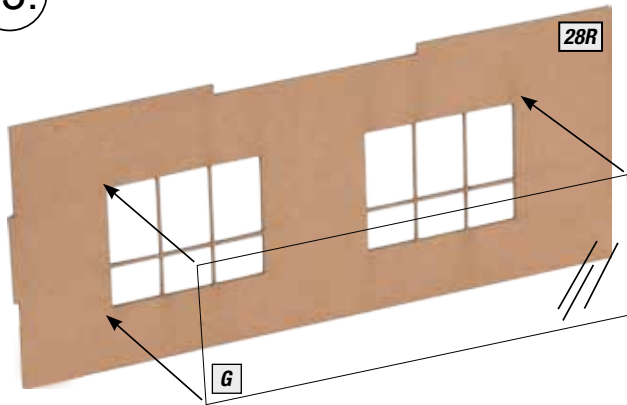

34.



35.

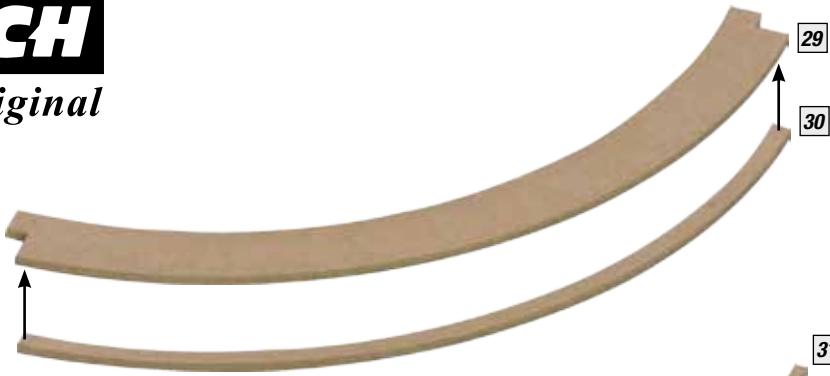

36.

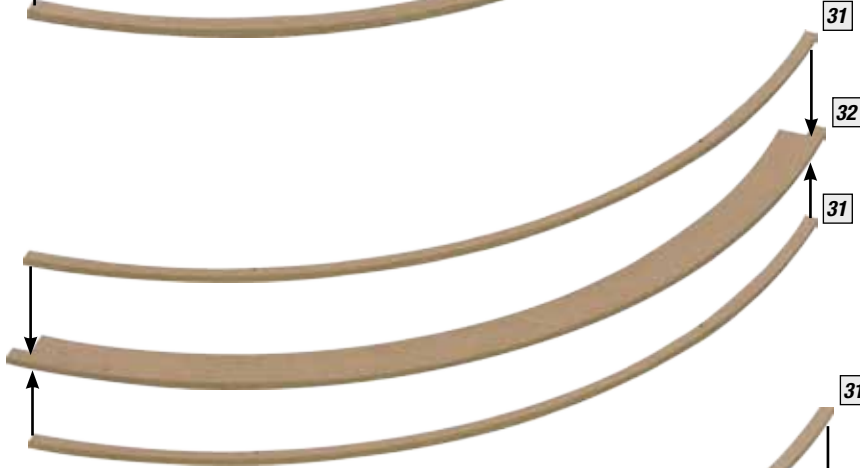

37.



38.

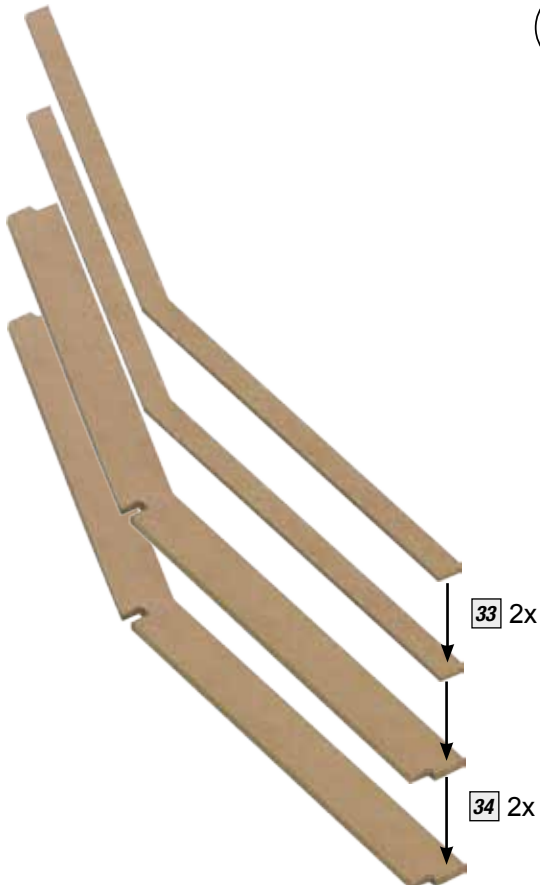

39.

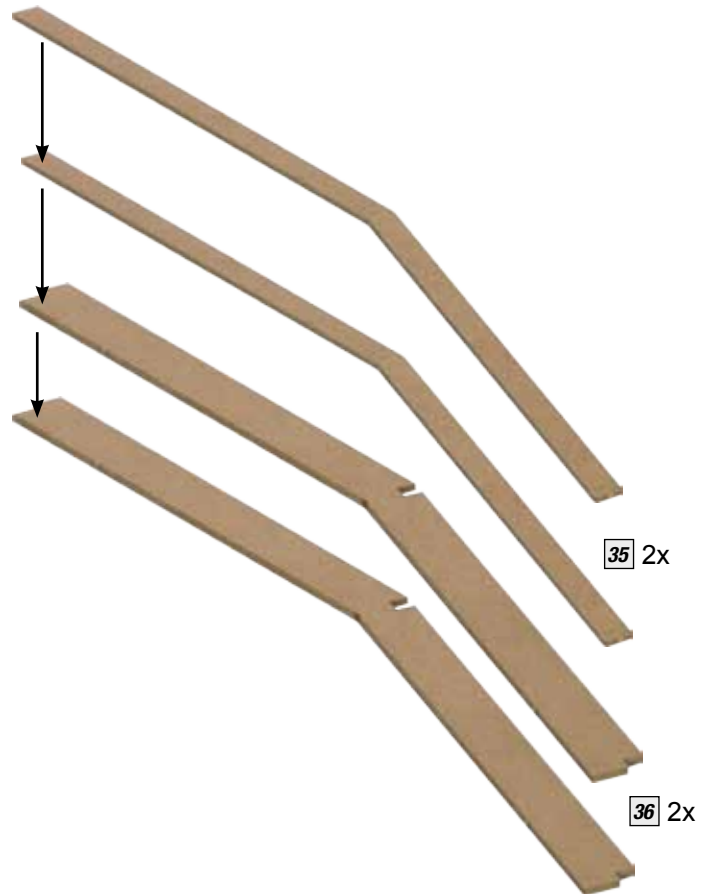

35.



36.



37.



39.



38.





41.

35.

36.



37.

42.



43.

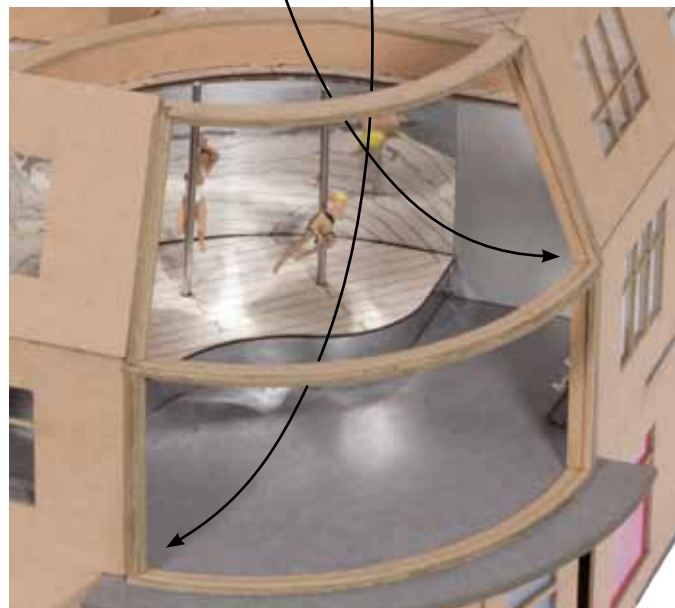
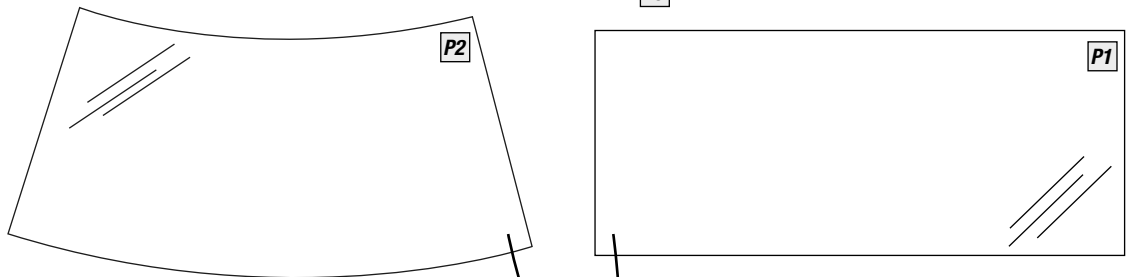

44.



45.



46.



47.

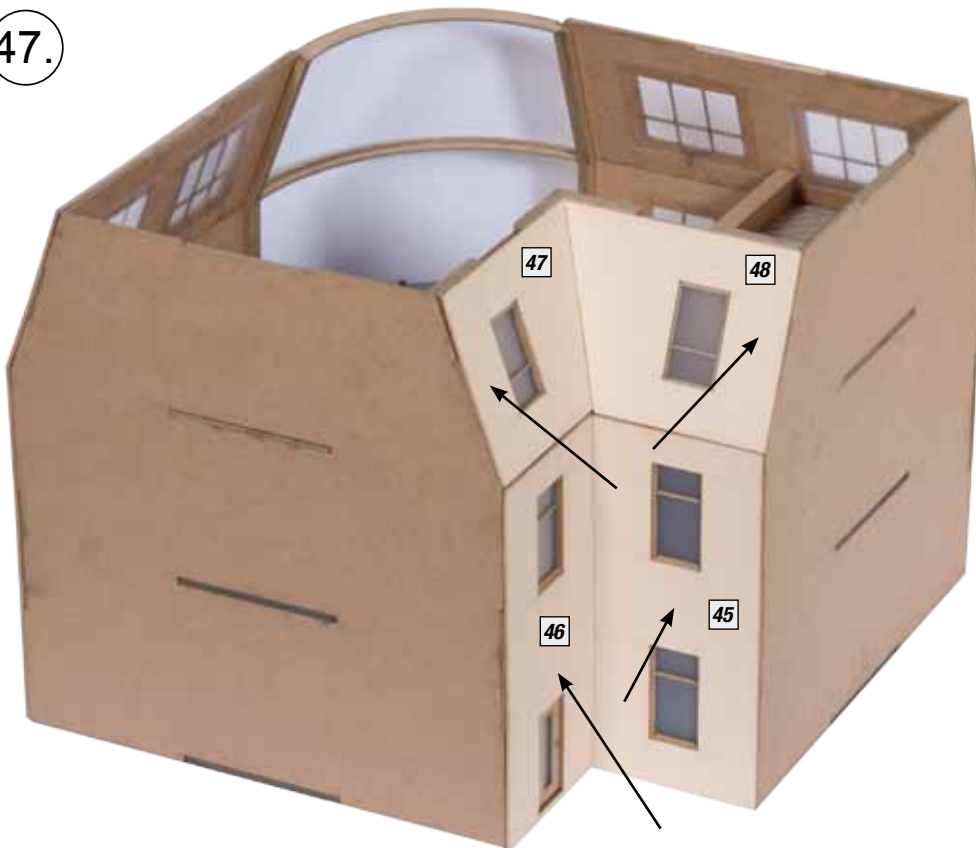

1. 45
2. 46
3. 47
4. 48

48.

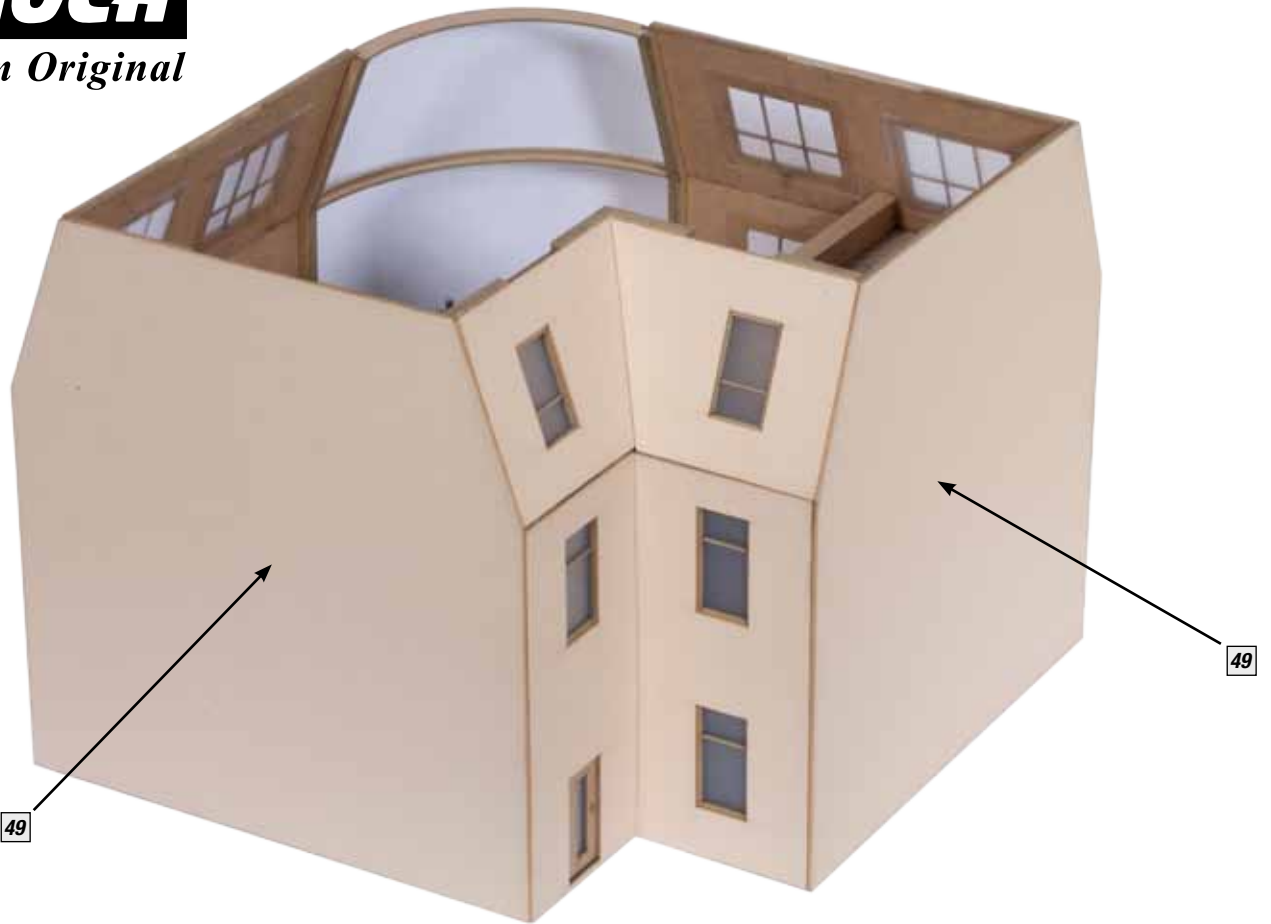

49.

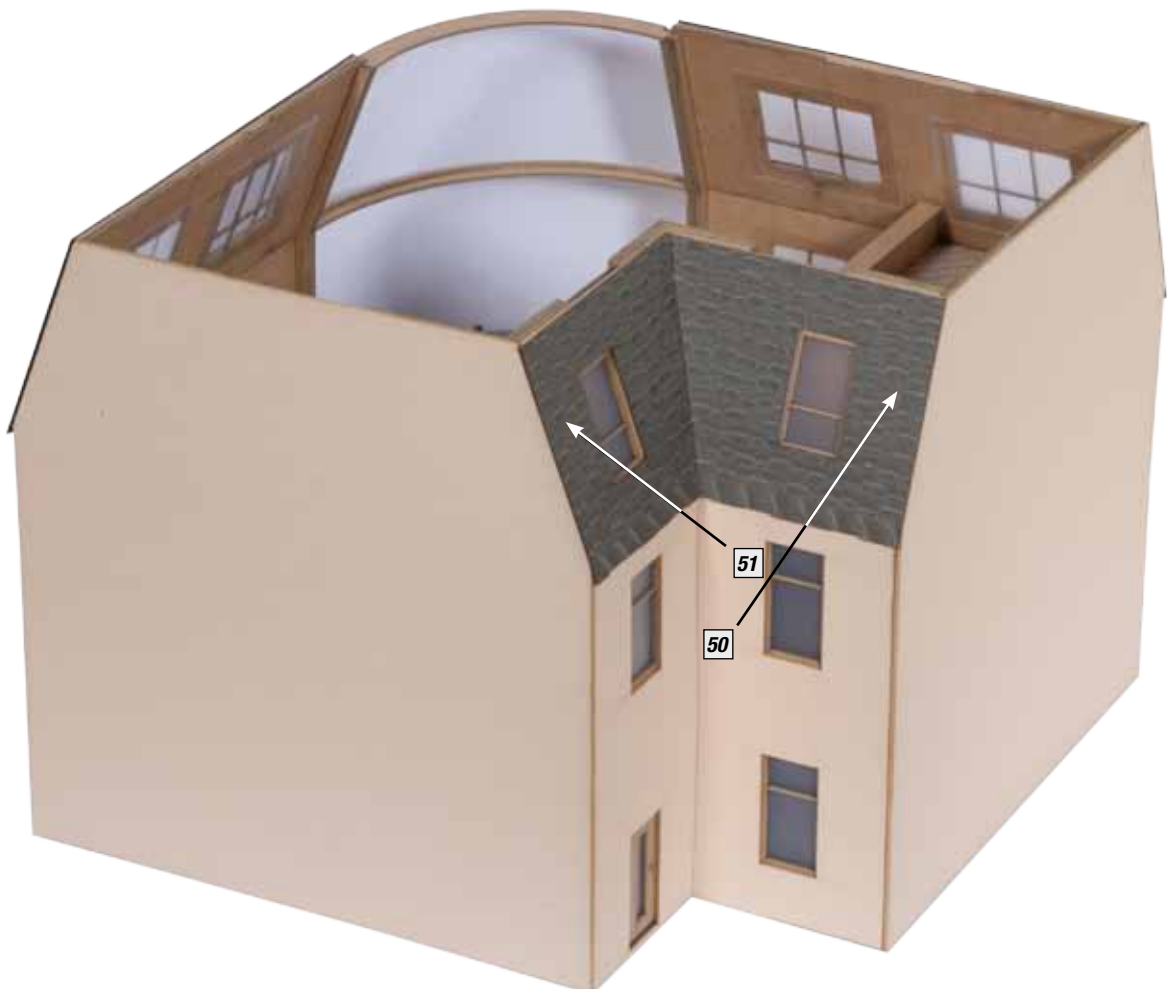

50.



51.

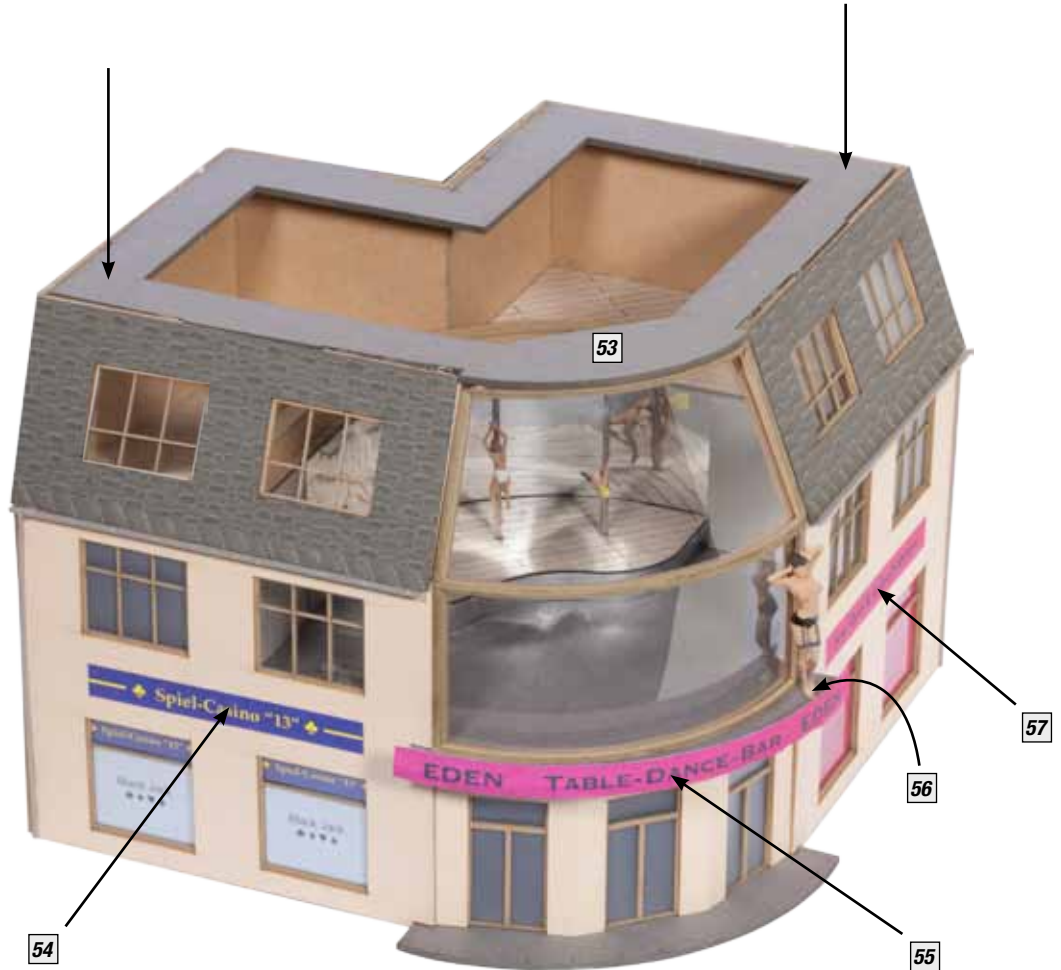

52.

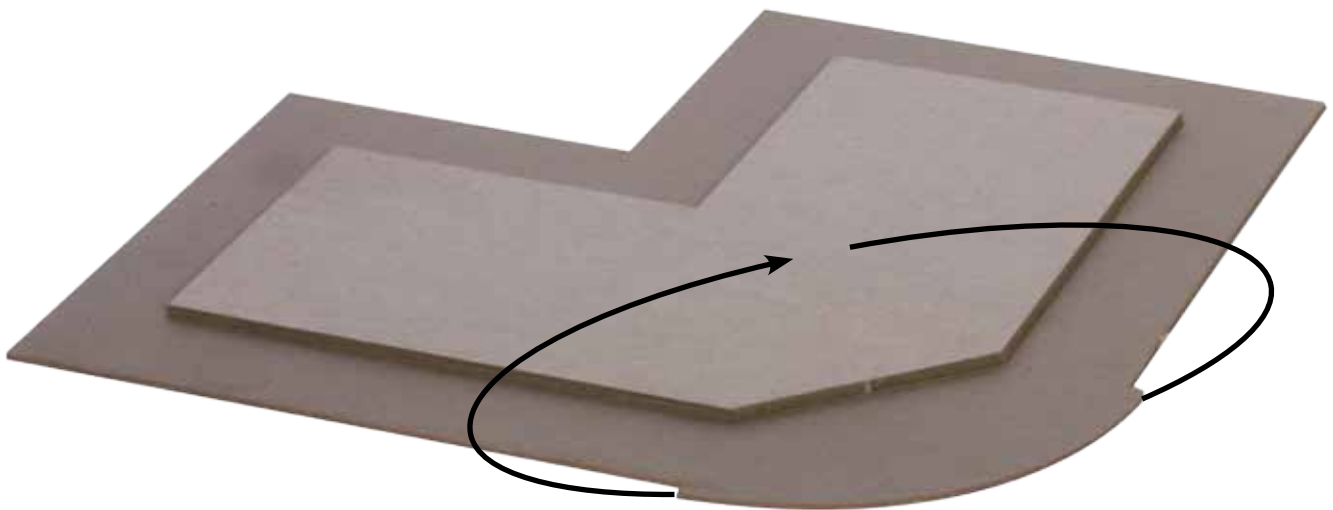
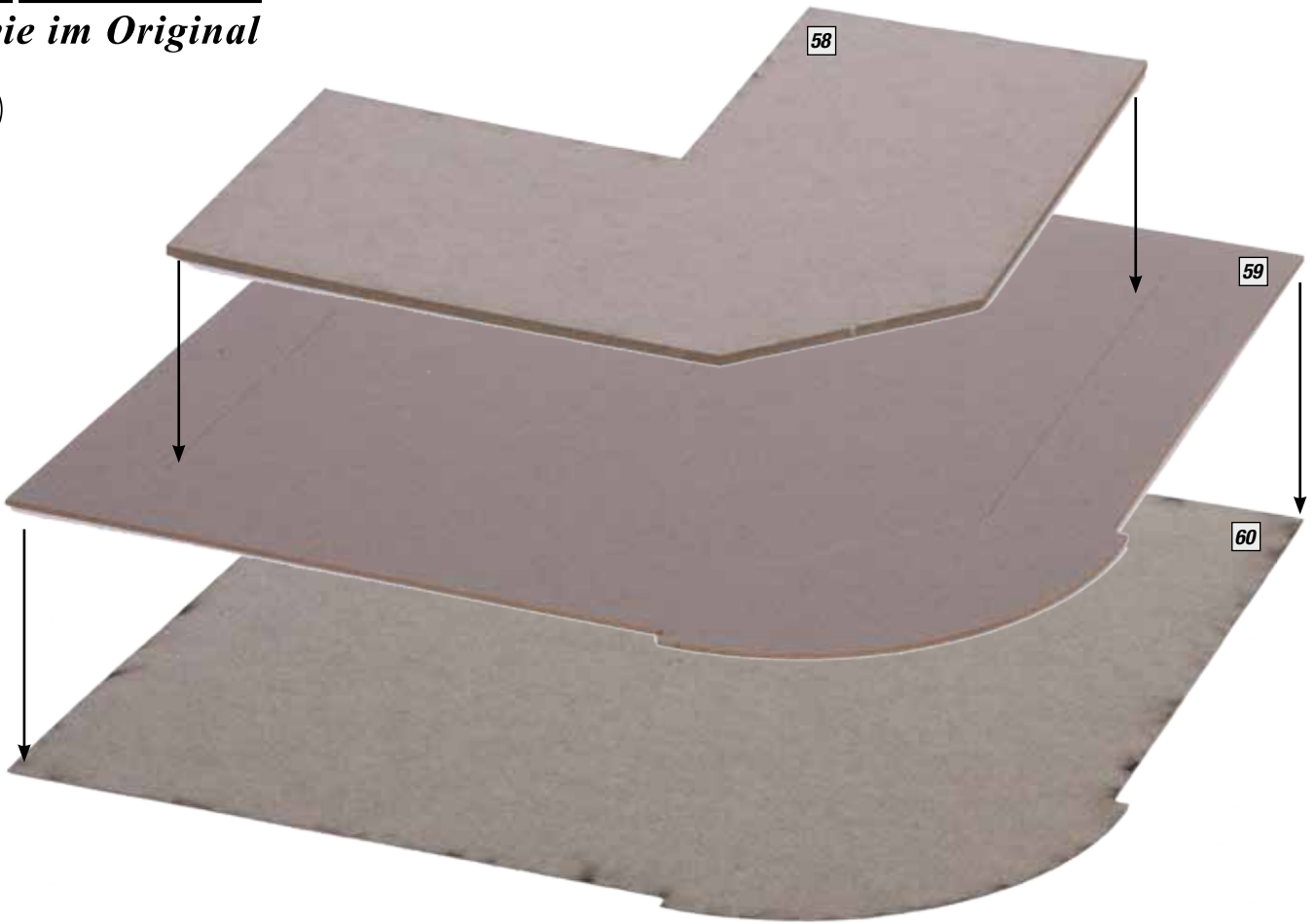

53.

52.

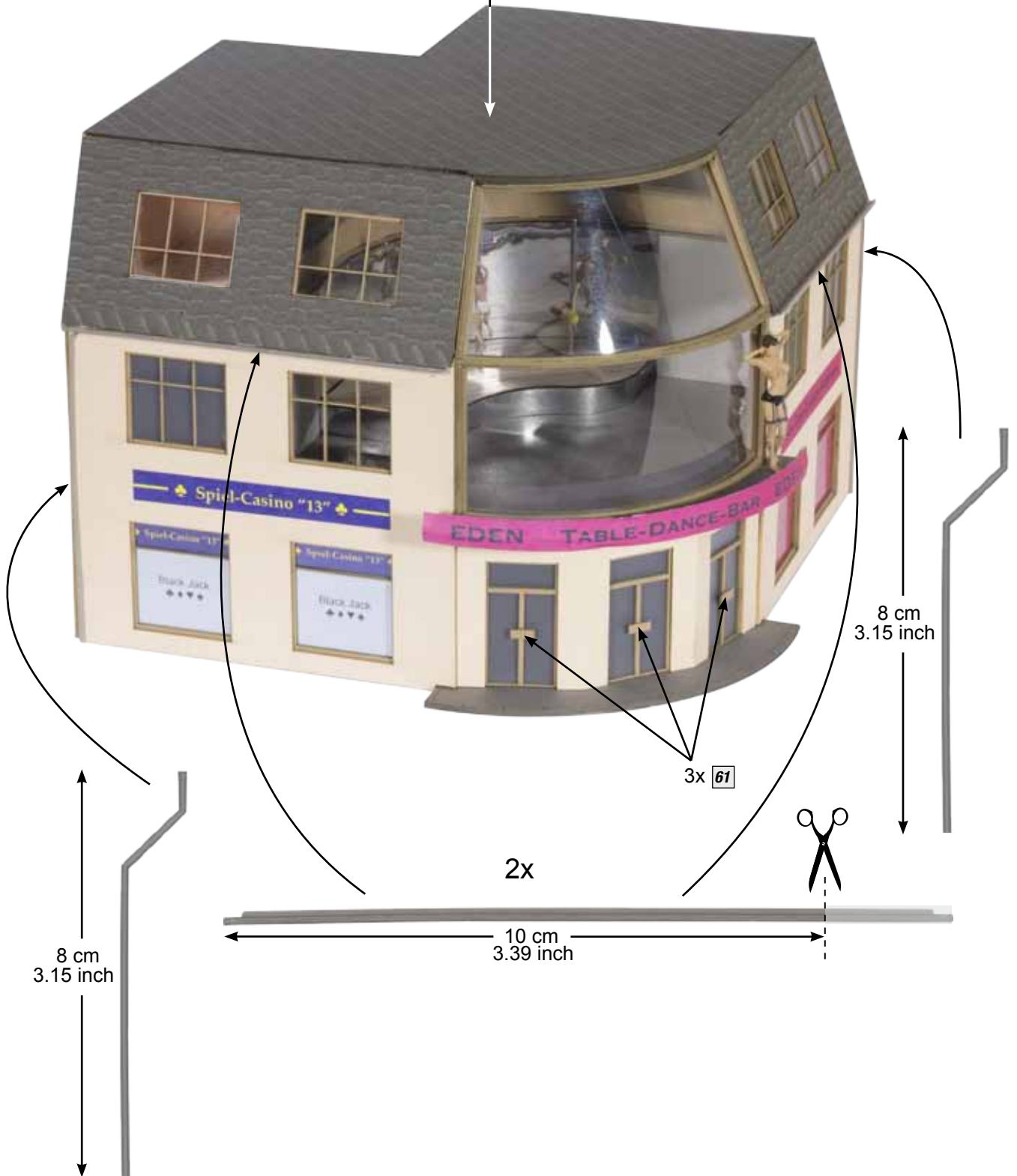

54.

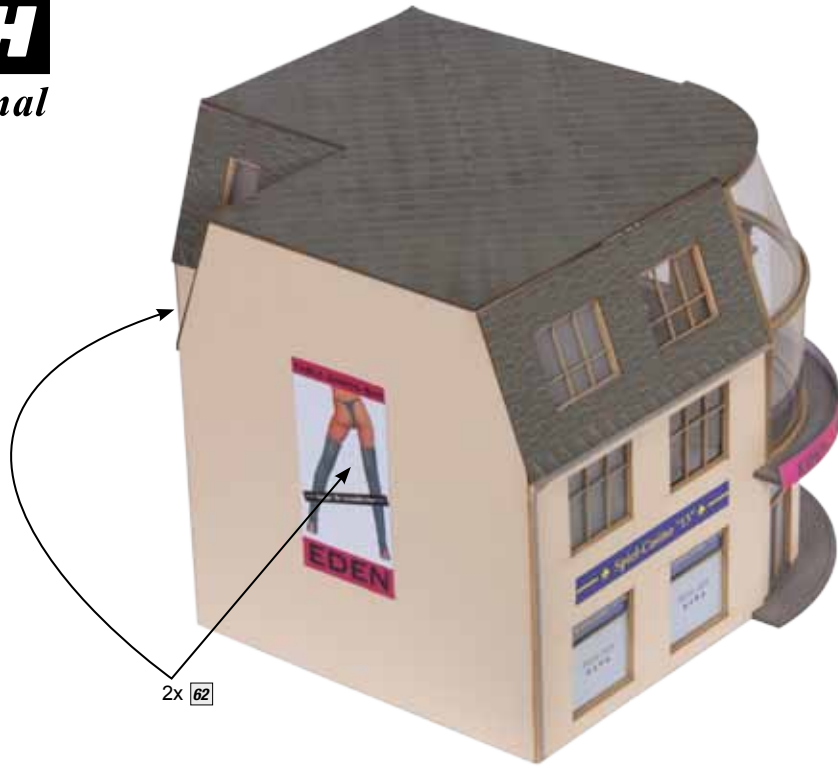

55.



2x 62



56.

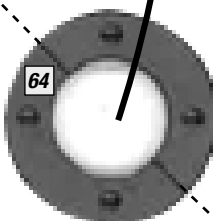
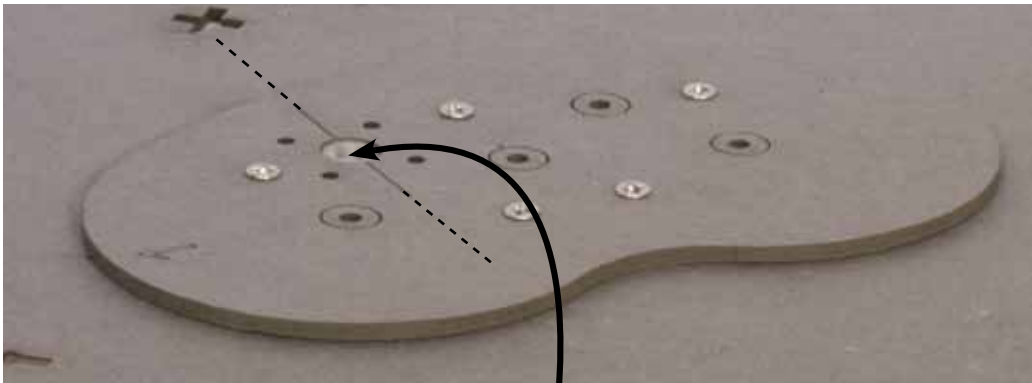

57.

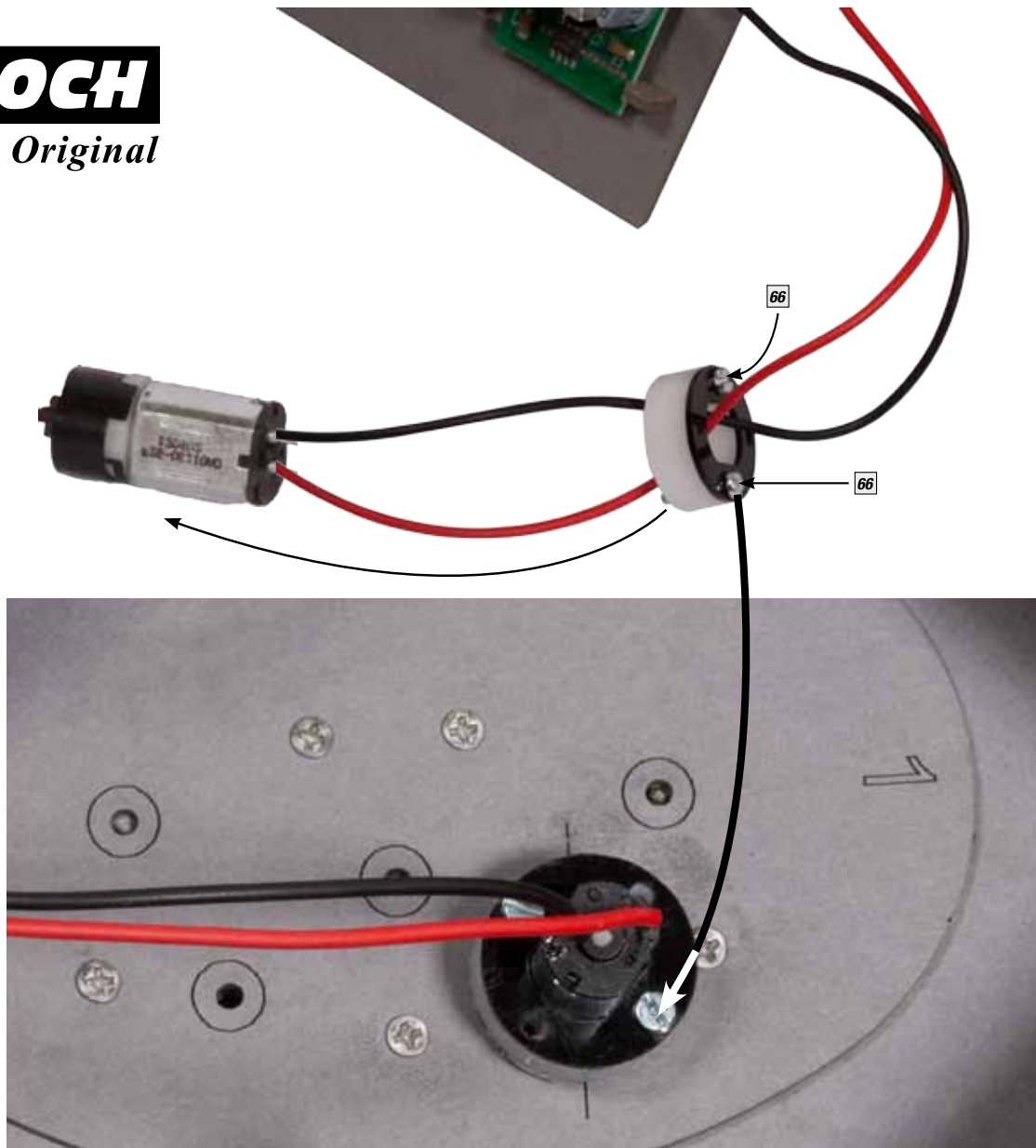

Achtung : Schrauben vorsichtig anziehen ! Motor bleibt leicht beweglich !

Attention : Tighten the screws carefully ! The motor remains a little flexible !

58.

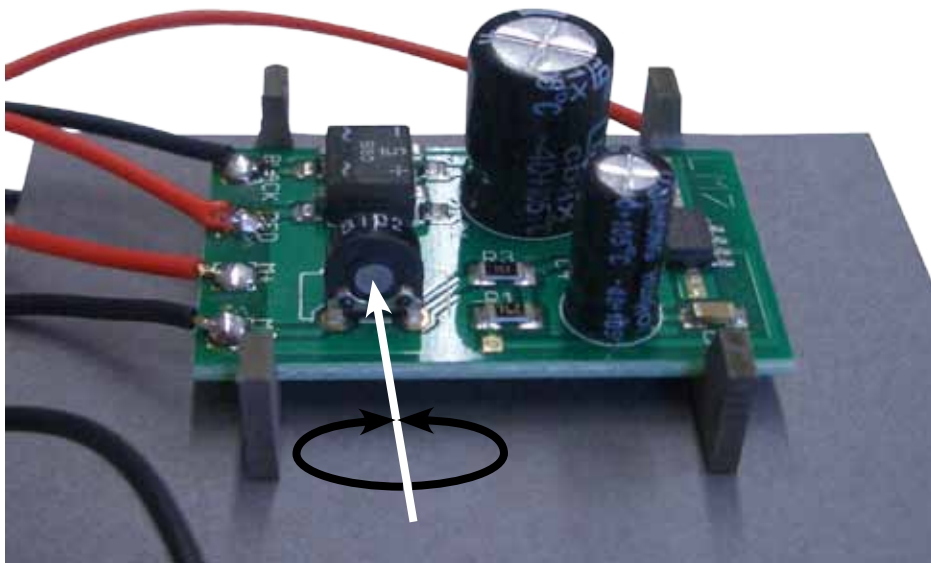

Achtung : Hier wird die Drehgeschwindigkeit des Motors eingestellt !

Attention : Regulate here the rotational speed of the motor !